



Innovations

Solutions for safe automation,
electrical safety and power electronics

DOLD 
Our experience. Your safety.

Innovations

DOLD offers an integrated program for safe automation, electrical safety and power electronics, which have already been in use successfully worldwide for many decades.

In addition to mono-functional standard devices up to multi-functional solutions, DOLD develops tailor-made products for your machines and plant protection.

You can find further information on our homepage under www.dold.com.

Contents

Safety technique

- Safety switch and key transfer system
SAFEMASTER STS
- Emergency stop module
SAFEMASTER
- Standstill and speed monitoring
SAFEMASTER S
- Multifunctional safety modules
SAFEMASTER C
- Software free safety system
SAFEMASTER M
- Configurable safety system
SAFEMASTER PRO
- Wireless Safety System
SAFEMASTER W

Measuring and monitoring technique

- Insulation fault location system
VARIMETER EDS
- Residual current monitoring
VARIMETER RCM

- Insulation monitoring
VARIMETER IMD

- Multifunction measuring relay
VARIMETER PRO

- Measuring and monitoring relays
VARIMETER

Power electronics

- Smart motorstarter, Softstarters
MINISTART
- Solid state relays / contactors
POWERSWITCH

PCB relays

- Safety relays with forcibly guided contacts
- Bistable relay with forcibly guided contacts

Find the right product for your application!

With our Product Finder you have direct and quick access to our product range of relay modules.

www.dold.com/productfinder



PRODUCT
FINDER

Start now!



SAFEMASTER STS

The key to more safety

DOLD 

Don't you wish you had a simple **safety switch and trapped key interlock system** to protect your dangerous working areas. If you are looking for a reliable, expandable, flexible and cost saving solution, then you have found the perfect product with our TÜV-approved system **SAFEMASTER STS**.

The **SAFEMASTER STS** Program consists of modules that can be individually combined and adapted to your application. They combine the advantages of safety switches, interlocks and key transfer in one system. The modular design allows systems to be assembled out of several units, or to modify and expand existing systems as required. All mechanical interlocks can be utilised in machine and plant concepts without wiring. They provide an economic and reliable protection in wide applications.

With only a few single components, a number of individual interlock units can be assembled. The stainless steel units guarantee good stability. Extensive equipment allows a simple mounting.

Advantages and customer benefit

- ▶ Combines advantages of safety switch, solenoid lock, trapped key interlock and command function in one System
- ▶ EC type approval certificate in accordance with the statutory requirements
- ▶ For safety applications up to Cat. 4 / PL e according to EN ISO 13849-1 as individual system
- ▶ Modular and expandable system
- ▶ Version available in plastic as well as a in rugged stainless steel
- ▶ Wireless safeguarding
- ▶ Easy installation through comprehensive accessories
- ▶ Protection against lock-in
- ▶ Fault exclusion is not required

Our experience. Your safety.

Safety switch and trapped key interlock system

System

The system offers maximum safety and respects the requirements of the user concerning robustness, long life and user ergonomics. Special features are stainless steel units with ergonomic linear keys. It is flexible, can be easily extended and guarantees a safe and interruption free process, offering an intelligent and cost saving solution for industrial applications of all kinds.

Industries

- ▶ Automation technology
- ▶ Stone and cement processing
- ▶ Recycling
- ▶ Steel, wood and foodstuff industry
- ▶ Conveyor technology and logistics
- ▶ Railway and automotive industries

Application example

The image shows a part of the palletizing system with three access points. When opening the main access door A during operation, the machine stops immediately. To open the service doors B or C, one proceeds as follows: Remove the key A, insert the key on door B, remove the second key, open the door B. The machine can be restarted in the reverse sequence.

Your advantage: Maintenance door B is secured without wiring and the key serves as a protection against unexpected start-up of the plant. Plastic units can be easily combined with the stainless steel version, for example in the outdoor area of a plant.

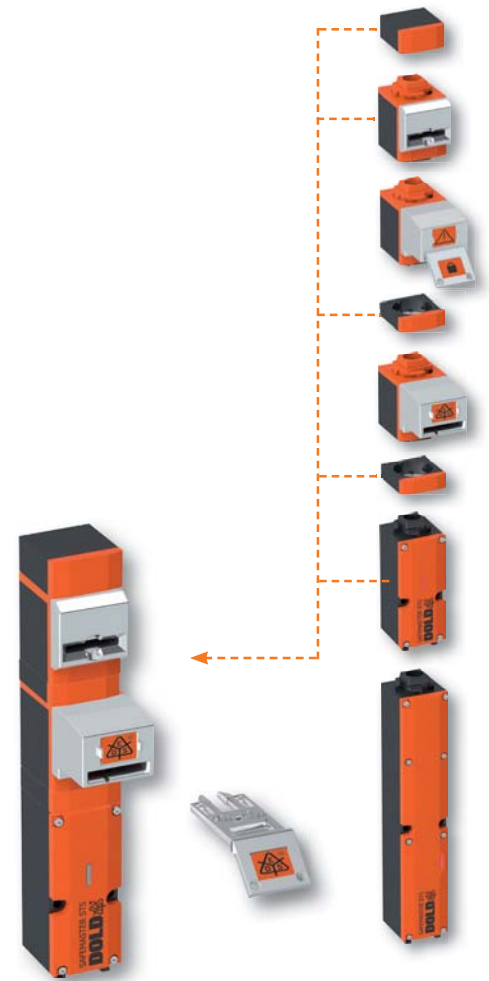

Example:
STS-Unit SX01BM

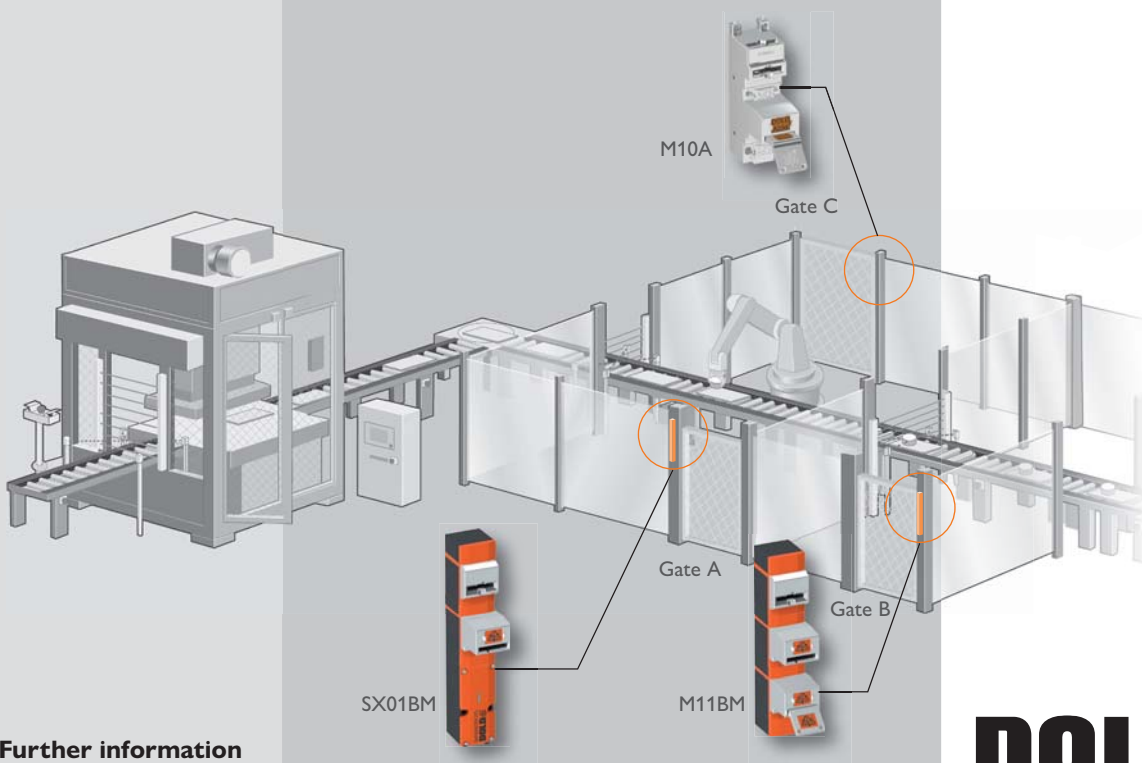

Further information

SAFEMASTER STS

Start

www.dold.com

DOLD

E. Dold & Söhne GmbH & Co. KG
Bregstraße 18 • D-78120 Furtwangen
T +49 7723 654-0 • F +49 7723 654-356
dold-relays@dold.com • www.dold.com



SAFEMASTER STS

DOLD 

Power Interlocking - Safely switched off!

Power Interlocking from the **SAFEMASTER STS** family by DOLD allows you to easily integrate a load-break switch into your safety switch and key transfer system. This lets you to directly deactivate and safely lock the energy supply to a machine or system. The safety system can then reliably protect personnel from entering the hazardous area. At the same time, Power Interlocking can easily be combined with other SAFEMASTER STS modules to wirelessly and mechanically safeguard safety doors. The system offers the best possible safety up to category 4 / PL e with EC type examination certificate.

The most important components of Power Interlocking are a load-break switch and a mechanical or electromechanical locking unit. When switched off, these release a key which opens a safety door to a hazardous area. The locking mechanism prevents the operating lever from being activated, thereby stopping the system from turning back on.

Power Interlocking forces the energy supply to the machine to be switched off and locked directly using a load-break switch, without the use of an electrical or electronic control level. For simple or machines or retrofitting machines, power interlocking offers the advantage that no controller is required. The system can, however, also be a good addition to more complex systems as a restart prevention.

Your advantages

- ▶ For safety applications up to cat. 4 / PL e
- ▶ Reduced installation and assembly work due to simple construction
- ▶ Load-break switch integrated into SAFEMASTER STS
- ▶ Electrical control level not required
- ▶ Safe restart protection by locking off energy supply
- ▶ High switching capacity of 25 A to 800 A
- ▶ EC type examination certificate

Our experience. Your safety.

Power Interlocking – Safely switched off!

Technical features

- ▶ Application range up to category 4 and performance level (PL) e in accordance with EN ISO 13849-1
- ▶ Emergency off or zone stop
- ▶ High switching capacity, currents of 25 A to 800 A (AC23)
- ▶ Different designs available
 - Mechanical
 - Safety switch
 - Safety switch with lock
- ▶ Safe lock, even if auxiliary or control circuits fail
- ▶ Load-break switch auxiliary contacts can be used in combination with time relay or standstill monitor
- ▶ Especially well-suited for central switch-off and release



SAFEMASTER STS
Power Interlocking ZRH01SLPR40

Applications

The application example shows a baling press with additional packaging unit, combined with SAFEMASTER STS Power Interlocking. After the complete system has been switched off using the load-break switch, the key can be removed and other keys can be released as needed. The key can be used to open the various safety doors on the system, for example to perform maintenance. The system can only be restarted after all keys are returned to their initial positions.

Application examples

- ▶ Baling press
- ▶ Paper and printing industry
- ▶ Mixers
- ▶ Recycling industry
- ▶ And much more ...

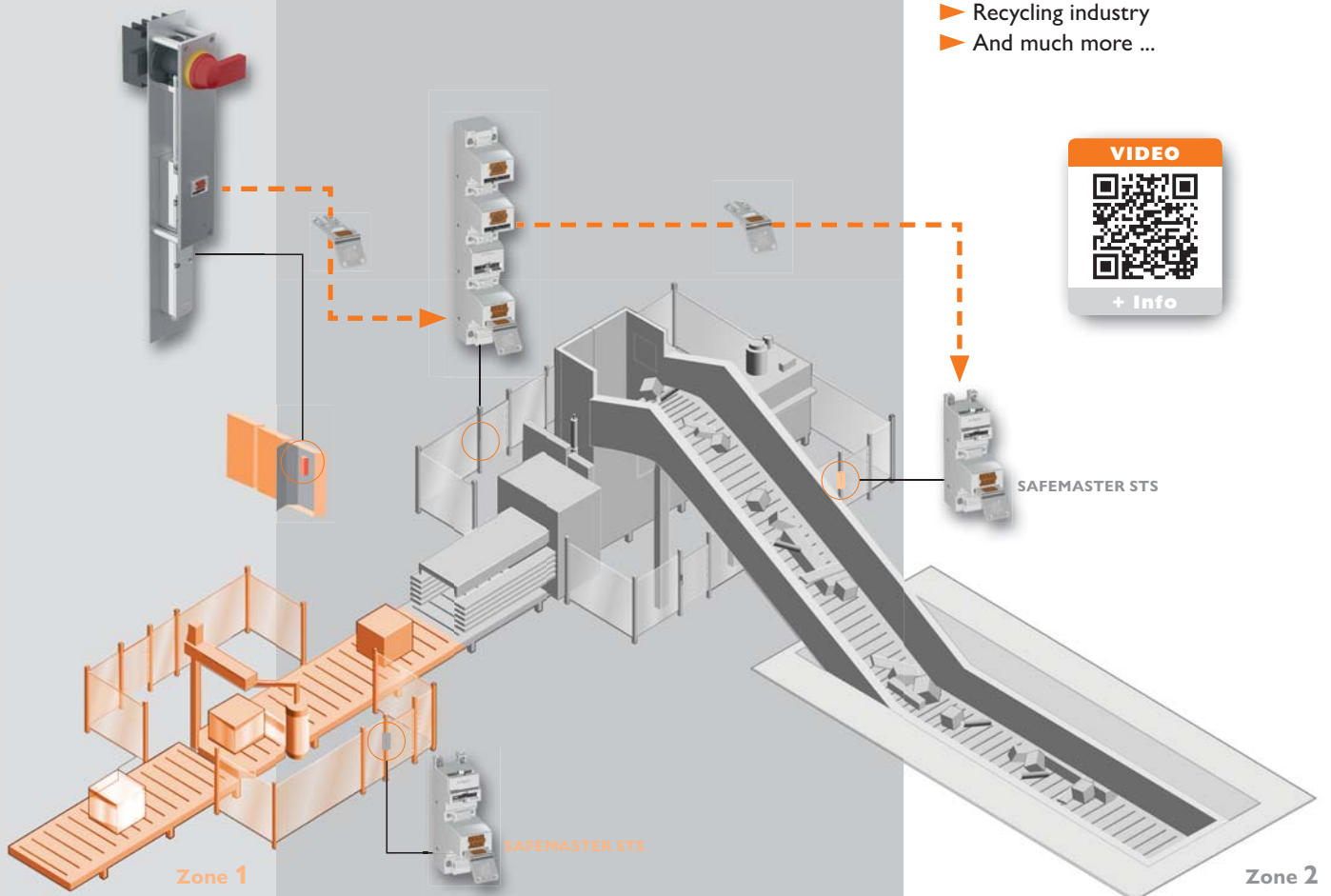

Further information

Power Interlocking

Start

www.dold.com

DOLD

E. Dold & Söhne GmbH & Co. KG
Bregstraße 18 • D-78120 Furtwangen
T +49 7723 654-0 • F +49 7723 654-356
dold-relays@dold.com • www.dold.com



SAFEMASTER STS

DOLD 

Option module – Decentralized Control Center

The robust stainless steel **option module** expands the modular **SAFEMASTER STS** safety switch and key transfer system by adding variable command, indication, selection and emergency stop functions. This makes the system a true “control center” which can be used to control command functions, additional displays, releases, and main and maintenance access points. The option module can be installed interlocking directly below the safety switch or locking units, facilitating direct command execution at machine and system access points. It is also possible to install it as a stand-alone control device. Benefit from the high flexibility of the system.

With just a few components from the SAFEMASTER STS system, you can assemble a large number of different locking units and combine these with various option modules. This results in a large number of possible units with command functions.

The specialized ribbon cable with plug connectors ensures individual components can be connected easily and quickly internally. The standard design is made of stainless steel, ensuring the best possible stability and safety, even in rugged or extreme environmental conditions. Comprehensive accessories allow for simple, fast assembly directly at the access point.

Your advantages and customer benefits at a glance

- ▶ Simple integration of command and indication functions in SAFEMASTER STS
- ▶ Space-saving installation on protective fence thanks to narrow 40 mm size
- ▶ Highly robust stainless steel design makes the unit suited for rugged and extreme environmental conditions
- ▶ Large selection of different operating elements such as emergency stop buttons, illuminated buttons, push buttons and selector switches
- ▶ Protect personnel and systems up to the highest safety category 4 / PL e
- ▶ Reduced assembly and wiring work through integrated operating elements and wireless safeguard for safety doors

Our experience. Your safety.

Option module – Decentralized Control Center

Technical features

- ▶ Control function through illuminated buttons or emergency stop buttons
- ▶ Pluggable connection technology with double spring-clamp terminals for cables up to 1.5 mm²
- ▶ Robust stainless steel housing
- ▶ Can also be installed as stand-alone unit
- ▶ Bottom M20 and 2 side M25 cable glands, top M20 cable gland
- ▶ Optional connection set for plug connection between switch / locking module and option module
- ▶ Plug connection between control station in cover and option module
- ▶ Colored panels and icon signs selectable

Order information

- ▶ Option module with 1 emergency stop button, 2 illuminated buttons
Standard type: Option module TTN
Item number: 0066342
- ▶ Option module with 3 illuminated buttons
Standard type: Option module TTT
Item number: 0066343

Applications

The image displays a system with multiple access points. Before releasing the main access using the locking unit, the release button on the option module must be pressed. This ensures that the machine or system moves into a safe position. Only then is it possible to open the main access and maintenance doors. Only once the protective doors have been appropriately closed and the key is back in the locking unit can the system be re-started using the two release buttons. The option module can also be integrated into system controls as a stand-alone control unit, in order to outfeed faulty parts, for instance, or adapt processing speeds.



Option module TTN / TTT / TTW

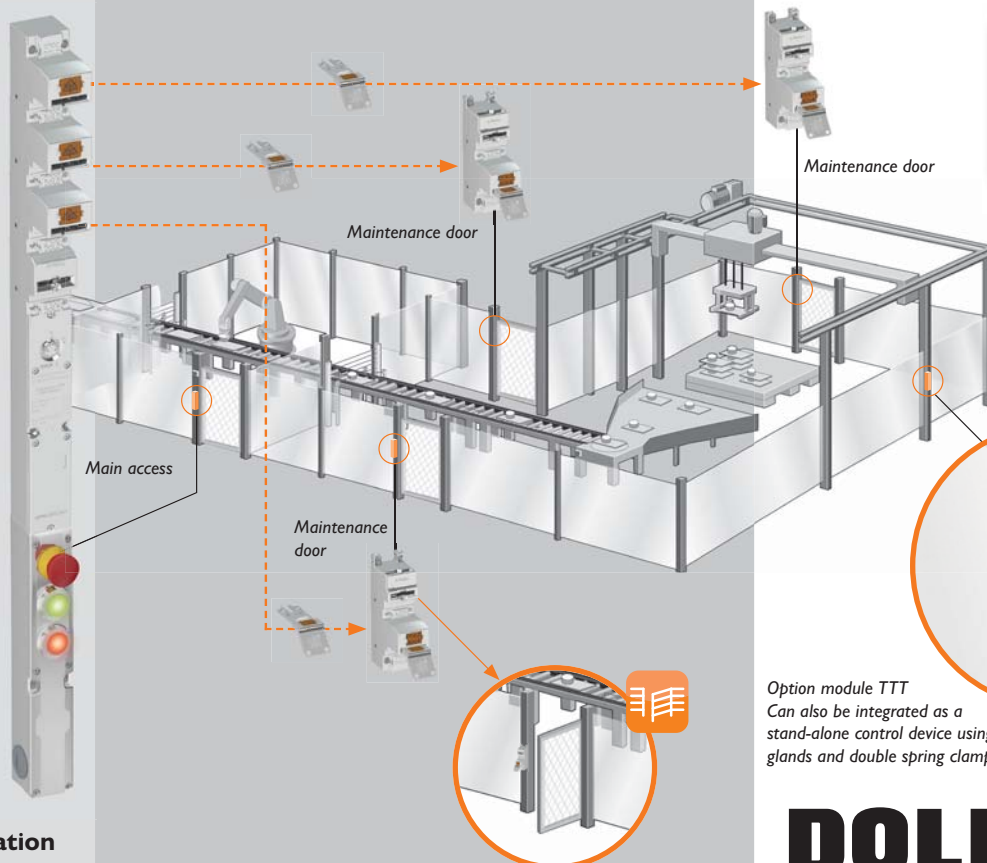

Option module TTT
Can also be integrated as a stand-alone control device using cable glands and double spring clamp terminals.

Further information

Option module

Start

www.dold.com

DOLD

E. Dold & Söhne GmbH & Co. KG
Bregstraße 18 • D-78120 Furtwangen
T +49 7723 654-0 • F +49 7723 654-356
dold-relays@dold.com • www.dold.com



SAFEMASTER

Emergency stop module UF 6925 - Compact safety just 17.5 mm wide

DOLD 

The only 17.5 mm wide **emergency stop module UF 6925** of the **SAFEMASTER** series monitors safety functions such as emergency stop or safety door safely and simply in nearly every application and is characterised by maximum safety for man and machine with minimum space requirement. The UF 6925 enables time-saving wiring by integrated front side push-in cage clamp terminals and also makes rapid assembly possible by simple snapping on to the DIN rail.

Being only 17.5 mm wide, the space required in control cabinets is reduced by more than 20 %, as opposed to standard safety modules. Due to its 2-channel structure the device is designed for highest safety requirements up to cat. 4 / PL e or SIL 3 and is also suitable for use in furnace installations according to EN 50156-1 due to the redundant structure. Setting is carried out via switches on the back of the device and allows the selection of type of start and cross fault detection.

The safety module is predestined thanks to its wide voltage range of DC 8 ... 36 V for a great variety of applications in machine and plant engineering and in mobile applications.

Advantages and customer benefit

- ▶ For safety applications up to cat. 4 / PL e or SIL 3, UL-listed
- ▶ Wide voltage range of DC 8 ... 36 V
- ▶ Compact construction type only 17.5 mm wide
- ▶ Rapid wiring via integrated push-in connection technology
- ▶ Rapid diagnosis using LED display
- ▶ Suitable for safety functions such as safety door and emergency stop
- ▶ Adjustable type of start with line fault detection on On-button
- ▶ Front side device connection

Our experience. Your safety.

Emergency stop module UF 6925

Technical features

- ▶ Complies with
 - Performance Level (PL) e and category 4 according to EN ISO 13849-1
 - SIL Limit (SIL CL) 3 according to IEC/EN 62061
 - Safety Integrity Level (SIL) 3 according to IEC/EN 61508 and IEC/EN 61511
- ▶ In accordance with EN 50156-1 for furnace installations
- ▶ 2-channel structure
- ▶ Forcibly guided output contacts
- ▶ With or without cross fault detection in control circuit, switch S1
- ▶ Activation via ON button or automatic ON function, switch S2
- ▶ LED indicators for channel 1, 2 and network
- ▶ 17.5 mm width



Emergency stop module
UF 6925



Order information

Standard type: UF 6925.03/61 DC 8 ... 36 V
Item number: 0067556

Applications

- ▶ Battery supplied systems
- ▶ Automated guided vehicle systems
- ▶ Machines and plants
- ▶ Construction vehicles and crane assemblies

Application example

The application example shows the monitoring of safety door and emergency stop in a machine. The narrow emergency stop module saves space and can be used simply in nearly every application.

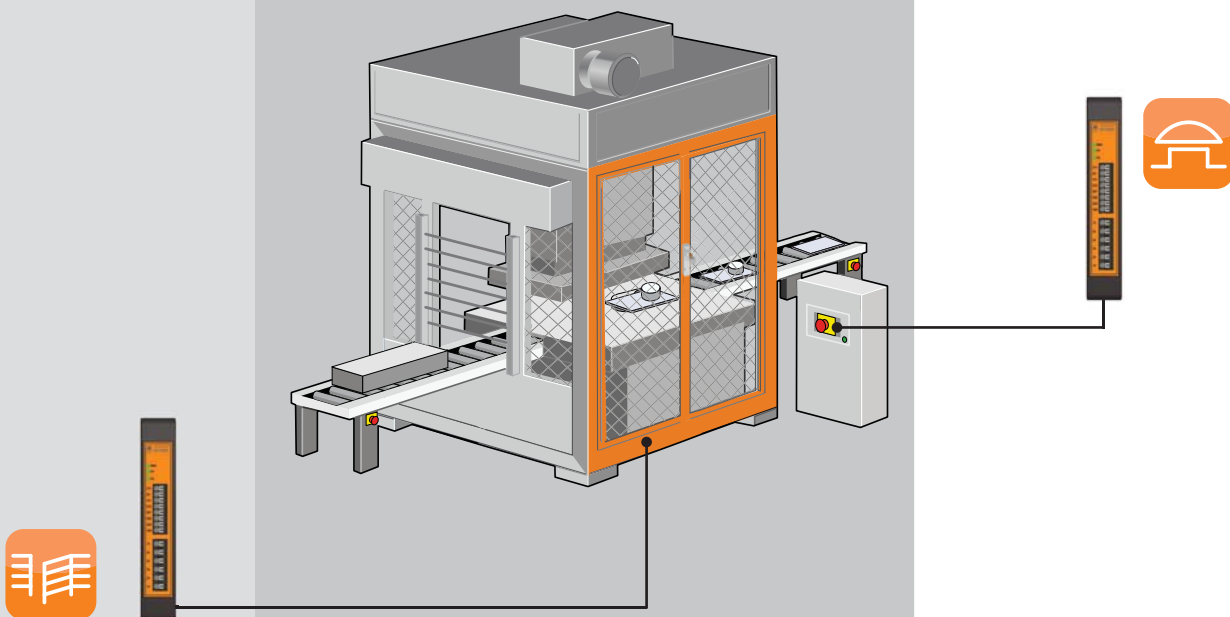

Further information

UF 6925

Start

www.dold.com

DOLD

E. Dold & Söhne GmbH & Co. KG
Bregstraße 18 • D-78120 Furtwangen
T +49 7723 654-0 • F +49 7723 654-356
dold-relays@dold.com • www.dold.com



SAFEMASTER S

DOLD 

Standstill monitor UG 6946 - Safe sensorless standstill monitoring

The safe sensorless **standstill monitor UG 6946** from the **SAFEMASTER S** series detects the standstill of 3-phase and 1-phase motors independent of the direction of rotation. This means sensors such as encoders or proximity switches are not required. Access to the danger zone of a system is only possible by the enabling signal of the standstill monitor after the drive has been switched off and run down. In order to detect a standstill, the remanence voltage induced by the motor windings is evaluated and provides safe standstill monitoring up to Cat. 4 / PL e or SIL 3, even if the motor has already been switched off. Using a conventional release via a time control, dangerous movement could not necessarily be excluded. For the implementation of different operating modes, the standstill monitor UG 6946 also offers the possibility of bridging the standstill monitoring (muting).

The simple integration into the machine and drive concept reduces the commissioning effort and costs and is particularly suitable for use in machine tools and woodworking machines, centrifuges and rolling drives. With a width of only 22.5 mm, the UG 6946 can be accommodated in the control panel even under tight space conditions allowing easy retrofitting. The device also offers two redundant safety contact paths and a forcibly guided signal contact.

Your advantages

- ▶ Space saving in the switch cabinet due to only 22.5 mm width
- ▶ Adjustable response voltage 20 - 400 mV or 0.2 - 4 V
- ▶ Possibility of bridging the standstill monitoring (muting function)
- ▶ Standstill detection without additional sensors
- ▶ For safety applications up to Cat. 4 / PL e or SIL 3
- ▶ Rotary switches protected by sealable transparent cover
- ▶ Can be combined with safety interlock SAFEMASTER STS

Our experience. Your safety.

Standstill monitor UG 6946

Technical features

- ▶ According to
 - Performance Level (PL) e and category 4 to EN ISO 13849-1, EN 61800-5-2
 - SIL-Claimed Level (SIL CL) 3 to IEC/EN 62061
 - Safety Integrity Level (SIL) 3 to IEC/EN 61508, IEC/EN 61511 and EN 61800-5-2
- ▶ Safe standstill monitoring of 3- and 1-phase motors
- ▶ No external initiators required
- ▶ Independent of direction of rotation
- ▶ Wire break detection in the measuring circuit
- ▶ Forcibly guided output contacts:
 - 2 NO, 1 NC contact
- ▶ Adjustable voltage threshold
- ▶ Adjustable downtime
- ▶ LED displays for motor standstill, wire break and operating voltage
- ▶ Suitable for use with frequency converters
- ▶ Pluggable terminal blocks with screw or cage clamp terminals
- ▶ Possibility of bridging the standstill monitoring (muting)
- ▶ 22.5 mm width



Safe sensorless standstill monitor UG 6946

Order information

Standard type: UG 6946.02PS 20 ... 400 mV UH DC 24 V
Item number: 0068412

Application

For maintenance work, the plant is shut down in a controlled manner by actuating the stop function ①. Access to the hazardous machine area is monitored by the UG 6946 ②. Only after a safe standstill has been detected the standstill monitor releases the safety interlock and the protective door ③ can be unlocked. When the protective door is opened, dangerous movements must be switched off immediately and safeguarded against restarting. Only then can the service technician safely enter the system. The enabling switch is taken into the safety area of the machine for his own protection ④.

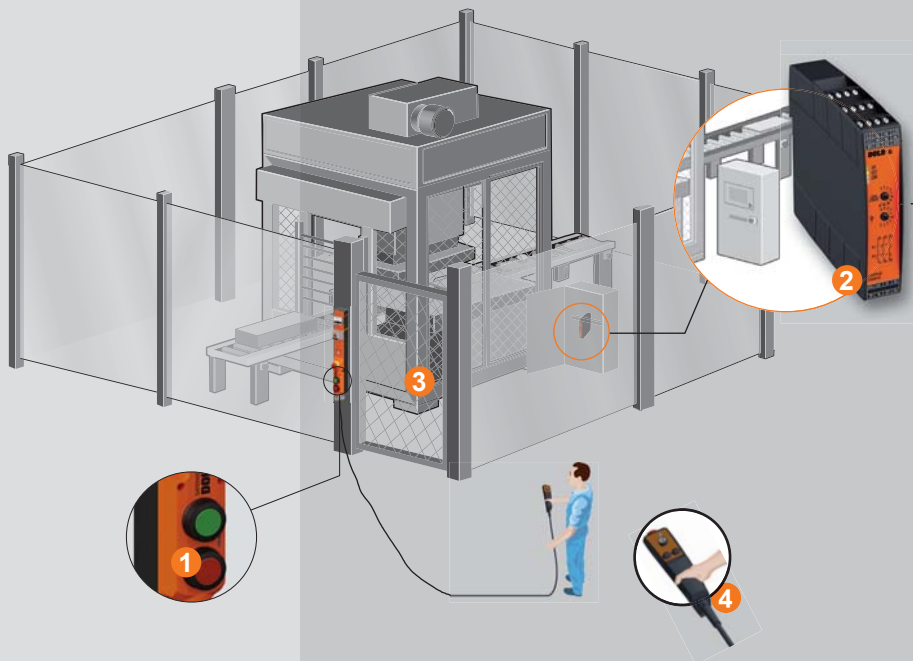

Fields of application

- ▶ Machinery and plant engineering
- ▶ Woodworking
- ▶ Machine Tools
- ▶ Conveying technology
- ▶ Metalworking

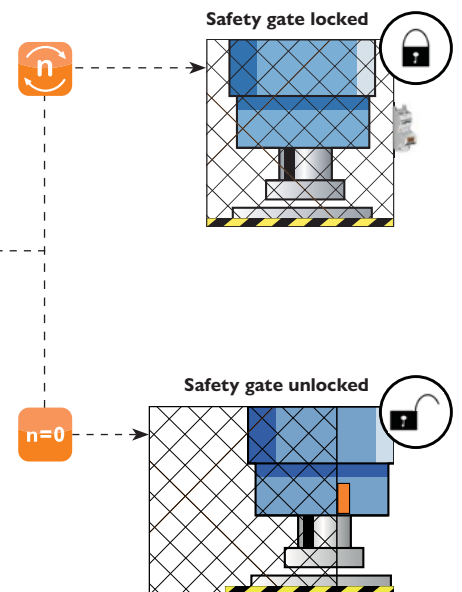

Further information

UG 6946

Start

Are you looking for further solutions for speed monitoring?

UH 6932

www.dold.com

DOLD

E. Dold & Söhne GmbH & Co. KG
Bregstraße 18 • D-78120 Furtwangen
T +49 7723 654-0 • F +49 7723 654-356
dold-relays@dold.com • www.dold.com



SAFEMASTER S

DOLD 

Speed Monitor UH 6932 - Comfortable speed monitoring

With the safe **speed monitor UH 6932** from the **SAFEMASTER S** series, DOLD offers a comfortable solution for safety-oriented speed monitoring for use in wind turbines, centrifuges, or stage engineering. The device safely monitors machine standstill and both excessive and low speeds, in automatic and setup operating modes.

The speed monitor finds use in machines and apparatus which can pose a threat to people whilst running through mobile machinery or movable parts. Therefore, through the safe monitoring of reduced operating speed during usage, for example, the safety of operating personnel will be increased. The device also increases productivity, since there is no need to unnecessarily shut down equipment.

The UH 6932 offers an LCD display and front buttons, ensuring simple, comfortable operation and quick configuration of the device without a PC. The surveillance function can be deactivated via a digital input or activated during operation, with up to four pre-configured velocity modes with varying response thresholds. Besides the safety-oriented contact paths, the device also offers an analog output to display the current frequency.

Your advantages

- ▶ For safety applications up to cat. 4 / PL e or SIL 3, UL-listed
- ▶ Simple, time-saving start-up without a PC
- ▶ Suitable for commonly available proximity switches
- ▶ Reduced system downtime through comprehensive diagnostic functions
- ▶ Speed monitoring offers a bypass option (Muting)
- ▶ Up to 4 operating modes can be activated (e.g. automatic, set-up, or service mode)
- ▶ Overspeed, underspeed or window monitoring

Our experience. Your safety.

Speed Monitor UH 6932

Technical features

- ▶ Overspeed, underspeed or window monitoring
- ▶ User-friendly front display:
 - For convenient, menu-based parameter adjustment of parameters
 - for target and actual value displays in Hz
- ▶ Quick response time using cycle duration measurements of input frequency
- ▶ For PNP or NPN initiators
- ▶ Adjustable hysteresis
- ▶ Adjustable release delay of 0 ... 100 s
- ▶ Adjustable start-up bypass time of 0 ... 100 s
- ▶ Adjustable alarm delay of 0.1 ... 100 s
- ▶ Save alarm or auto-reset
- ▶ 2-channel construction
- ▶ Positively driven output contacts
- ▶ LED display and 2 semi-conducting signal outputs
- ▶ 45 mm construction width

Safety technology characteristics

Cat. 4 / PL e according to DIN EN ISO 13849-1
SIL CL 3 according to EN 62061 and EN 61800-5-2
SIL 3 according to IEC 61508 and EN 61511

Order information

Standard type: UH 6932.02PS/61 DC 24 V
Item number: 0066816

Functions

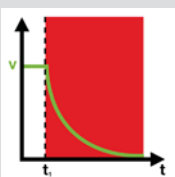
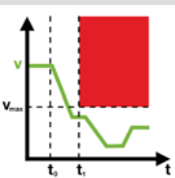
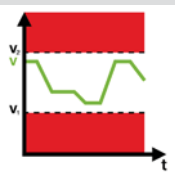
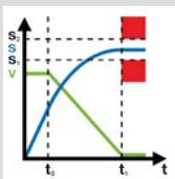

Safety functions in accordance with IEC 61800-5-2

Safe Operating Stop (SOS)

The SOS function stops the motor from deviating by more than a set amount from the stop position. The PDS (SR) provides the motor with the energy to keep it from being affected by external forces.

Safe Speed Range (SSR)

The SSR function keeps the motor speed within determined limits.

Safely Limited Speed (SLS)

The SLS function stops the motor from exceeding the determined speed limit.

Safe Torque Off (STO)

No energy is delivered to the motor that could cause it to turn (or move, with a linear motor). The PDS (SR) delivers no energy to the motor that could create torque (or force, with a linear motor).

Further information

www.dold.com

Are you looking for a
safe sensorless
standstill monitoring solution?

LH 5946



Speed monitor
UH 6932

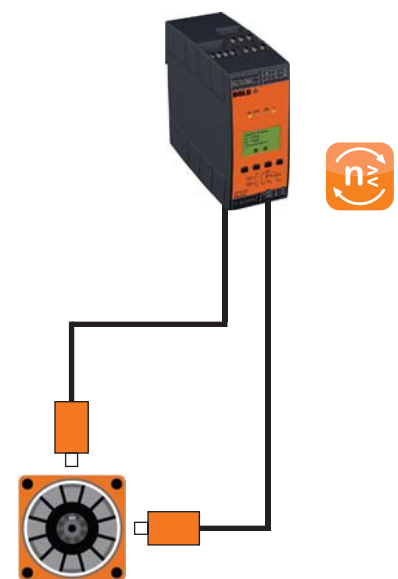

Convenient speed monitoring using
initiators, as well as simple, time-saving
start-up without a PC.

DOLD

E. Dold & Söhne GmbH & Co. KG
Bregstraße 18 • D-78120 Furtwangen
T +49 7723 654-0 • F +49 7723 654-356
dold-relays@dold.com • www.dold.com



SAFEMASTER S

DOLD 

Speed and frequency monitor UH 6937 - Safe, sensorless drive monitoring

With the **speed and frequency monitor UH 6937** from the **SAFEMASTER S** Series, DOLD offers an efficient, economic solution for safe, sensorless drive monitoring. Monitoring the output frequency of traction converters is just one of the many different ways to use this component. In case of over- or underfrequency, violation of the set window range or wrong direction of rotation the frequency monitor shuts off safely, proving its benefit over frequency converters with integrated safety functions in any application where simplicity, flexibility, and safety are required.

As an additional protective measure, the device can be adapted to an application by pressing just a few buttons. With the appropriate wiring, the device can offer the safety functions STO (safe torque off), SOS (safe operation stop), SLS (safely limited speed), SSM (safe speed monitoring), SSR (safe speed range) and SDI (safe direction) in accordance with EN 61800-5-2.

With the help of ergonomically shaped buttons on the front, and a lit LCD display, you can quickly and easily access parameters relevant for the application, such as monitoring functions, delay times, and frequency ranges for up to four operating modes – all without a PC.

Your advantages

- ▶ Direction of rotation monitoring up to PL d / Cat. 2 or SIL 2 while retaining PL e / Cat. 4 or SIL 3 for frequency monitoring
- ▶ Simple, time-saving start-up without a PC
- ▶ Sensorless and easy to upgrade
- ▶ Comprehensive diagnostic function
- ▶ Bypass option for frequency monitoring (Muting)
- ▶ Up to 4 operating modes can be activated (e.g. automatic, set-up, or service mode)
- ▶ Monitoring of over-, underfrequency, window range and direction of rotation
- ▶ For frequencies up to 1200 Hz and voltages up to AC 690 V

Our experience. Your safety.

Speed and frequency monitor UH 6937

Technical features

- ▶ Frequency monitoring corresponds:
 - PL e / Cat. 4 acc. to EN ISO 13849-1
 - SIL 3 acc. to EN 61508 and EN 61800-5-2
 - For frequency monitoring applications up to SIL 3 acc. to EN IEC 62061 and EN 61511
- ▶ Direction of rotation monitoring corresponds:
 - PL d / Cat. 2 acc. to EN ISO 13849-1
 - SIL 2 acc. to EN 61508 and EN 61800-5-2
 - For rotational direction monitoring applications up to SIL 2 acc. to EN IEC 62061 and EN 61511
- ▶ Over-, underfrequency or window monitoring of single or 3-phase in AC systems
- ▶ Direction of rotation monitoring with 3-phase AC voltage
- ▶ User-friendly frontside display:
 - for comfortably setting parameters through menus
 - for target and actual value displays in Hz
- ▶ Quick response time using cycle duration measurements of input frequency
- ▶ Adjustable hysteresis
- ▶ Adjustable release delay of 0 ... 100 s
- ▶ Adjustable start-up bypass time of 0 ... 100 s
- ▶ Adjustable alarm delay of 0.1 ... 100 s
- ▶ Manual or auto-reset
- ▶ Galvanic separation of measuring input, auxiliary voltage, and output contacts
- ▶ 2-channel design
- ▶ Positively driven output contacts
- ▶ LED display and 2 semiconductor signal outputs
- ▶ Optional analogue output and selection from up to 4 frequency modes
- ▶ 45 mm construction width



Safe, sensorless speed and frequency monitor UH 6937



Order information

Standard type: UH 6937.02PS/61 DC 24 V
Item number: 0066820

Fields of application

- ▶ Safe, sensorless drive monitoring
- ▶ Monitoring the output frequency of frequency converters
- ▶ Stage engineering
- ▶ Woodworking
- ▶ Machine tools
- ▶ Wind energy systems
- ▶ Crane systems



Safety functions acc. to IEC 61800-5-2

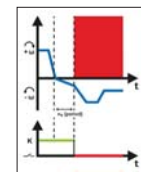

Safe Direction (SDI)

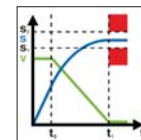

Safe Operating Stop (SOS)

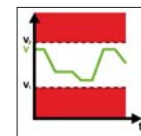

Safe Speed Range (SSR)

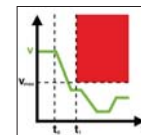

Safely Limited Speed (SLS)

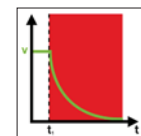

Safe Torque Off (STO)

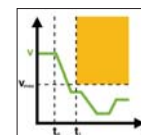

Safe Speed Monitor (SSM)

Further information

UH 6937

Start

Are you looking for more solutions for speed monitoring?

UH 6932

www.dold.com

DOLD

E. Dold & Söhne GmbH & Co. KG
Bregstraße 18 • D-78120 Furtwangen
T +49 7723 654-0 • F +49 7723 654-356
dold-relays@dold.com • www.dold.com



SAFEMASTER S

DOLD 

Speed and standstill monitor UH 5947 - More than just drive monitoring

Regardless of whether the set-up operation must be monitored safely, protection via speed limitation is needed or a safety gate is released after detection of standstill - the **speed and standstill monitor UH 5947** of the **SAFEMASTER S** series is the right choice for your application.

The device can be operated via the 4 buttons on the front and the LCD display, thus enabling simple parameterisation. For example, the encoder type, speed limits per operating mode and delay times can be flexibly adapted to your application. During operation, the current speed values can be read directly at any time, which in particular makes commissioning easier. To prevent manipulation, the configuration can be protected against unintentional changes by means of a parameter lock after commissioning. For multiple use, the configuration can easily be transferred from unit to unit via interface. The device status or the current speed can further be processed by a control system via a semiconductor signal output.

The speed and standstill monitor UH 5947 covers the combined application of encoder signals and PNP or NPN sensors. Alternatively, NAMUR sensor technology can be used as a device variant. The device can be used in temperature ranges from -20 to +60 degrees Celsius and up to heights of 4000 metres.

Advantages and customer benefits

- ▶ Controllable operating mode selection via input terminals
- ▶ Safety gate monitoring and solenoid control possible
- ▶ Feedback from drives through encoders and/or sensors
- ▶ Simple retrofitting into existing drive concepts by switching to encoders
- ▶ Monitoring of slip and shaft breakage through configurable speed ratio of the channels

Our experience. Your safety.

Speed and standstill monitor UH 5947

Technical features

- ▶ Separate speed limits for standstill, set-up and automatic operation
- ▶ SIN / COS, TTL and HTL encoders can be used
- ▶ Use of standard encoders possible
- ▶ Manipulation-proof due to parameter lock and change logging
- ▶ Screw, cage clamp or twin cage clamp terminals
- ▶ Approvals: TÜV, UL, CCC

Safety related data

Cat. 4 / PL e acc. to DIN EN ISO 13849-1
SIL CL 3 acc. to EN 62061 and SIL 3 acc. to IEC EN 61508

Dimensions in mm (H x W x D)

90 x 45 x 121

Order information

Standard type: UH5947.04 PS/61 DC 24 V
Item number: 0063476

Functions

Input: Flexible parameterisation of the sensor signals

Encoder



- SIN/COS
- TTL
- HTL

Sensors



- PNP
- NPN
- NAMUR

Combination



- Combination of encoder with sensors

Logic: Simultaneous monitoring

Standstill



Speed



Safety gate



Output: Evaluation and control

Standstill



Speed



Signal outputs



Further information

UH 5947

Start

www.dold.com



Speed and standstill monitor
UH 5947

Safety functions acc. to IEC 61800-5-2

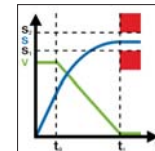

Safe Operating Stop (SOS)

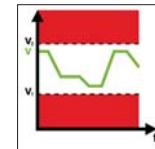

Safe Speed Range (SSR)

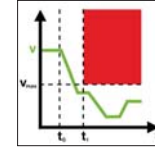

Safely-Limited Speed (SLS)

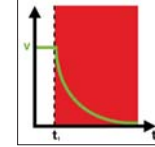

Safe Torque Off (STO)

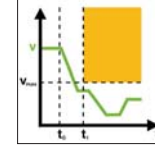

Safe Speed Monitor (SSM)

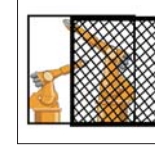

Safe Door Locking (SDL)¹⁾

1) Not defined in EN 61800-5-2

DOLD

E. Dold & Söhne GmbH & Co. KG
Bregstraße 18 • D-78120 Furtwangen
T +49 7723 654-0 • F +49 7723 654-356
dold-relays@dold.com • www.dold.com



SAFEMASTER S

DOLD 

Standstill Monitor LH 5946 - Sensorless safety standstill detection

The sensorless safety related **standstill monitor LH 5946** of the **SAFEMASTER S** family recognizes direction-independent the standstill of motors without making use of additional external sensors like encoder or proximity switch. The Standstill Detection is directly achieved by monitoring the voltage at the motor connection terminals.

Particularly when it comes to access protection, where regular intervention during production process is necessary, the sensorless standstill monitor LH 5946 can make use of its strengths. When there is no dangerous movement from the motor anymore the safety gate can be released within a very short time at detected standstill. Due to a variable adjustment of the response value and reaction time on the device, an individual adaption is possible.

Compared to solutions with time-controlled unlocking of safety gates, maintenance and setup times can be minimized by use of the sensorless standstill monitor LH 5946 and thus productivity can be improved.

Your advantages

- ▶ For safety applications up to cat. 4 / PL e / SIL 3
- ▶ Fast reaction time
- ▶ Easy commissioning by means of screwdriver
- ▶ Easy retrofitting, as there is no connection of sensors
- ▶ 2-channel safety monitoring with extended error diagnosis
- ▶ Reductions of down time of machines and installations
- ▶ Combinations with safety lock SAFEMASTER STS available

Our experience. Your safety.

Standstill Monitor LH 5946

Technical features

- ▶ Safe standstill monitoring of 3- and 1-phase motors
- ▶ Monitored feedback loop for downstream contactors
- ▶ Forcibly guided output contacts
3 NO + 1 NC
- ▶ For motor voltage up to 690 VAC
- ▶ No external sensors necessary
- ▶ Broken wire detection in the measure circuit
- ▶ Adjustable response voltage selectable from 20 to 400 mVAC or 0.2 to 4 VAC
- ▶ Adjustable standstill time delay from 0.2 up to 6 s
- ▶ Suitable for operation with inverters

Safety-related characteristics data:

Cat. 4 / PL e according to DIN EN ISO 13849-I
 SIL CL 3 according to IEC/EN 62061
 SIL 3 according to IEC/EN 61508, IEC/EN 61511 and EN 61800-5-2



Standstill Monitor LH 5946

Order information

Standard type:
 LH 5946.48/61 20 ... 400 mV UH DC 24 V 0,2 ... 6 s
 Item number: 0059266

Application

The application example describes a sensorless standstill monitoring of machinery and the release of a safeguard by means of safety lock. In doing so, the access to a dangerous machine area is being monitored and will only be unlocked after standstill.

Some typical application areas

- ▶ Machines and plant building
- ▶ Woodworking
- ▶ Machine tools
- ▶ Conveyors
- ▶ Steel plants

Detect

▶ As soon as the emergency stop is activated, the machine will be switched off.

Evaluate

▶ Standstill monitor supervises the speed of the machine.

Execute

▶ As soon as the motor is stopped the safety door will be released and unlocked by means of safety lock.

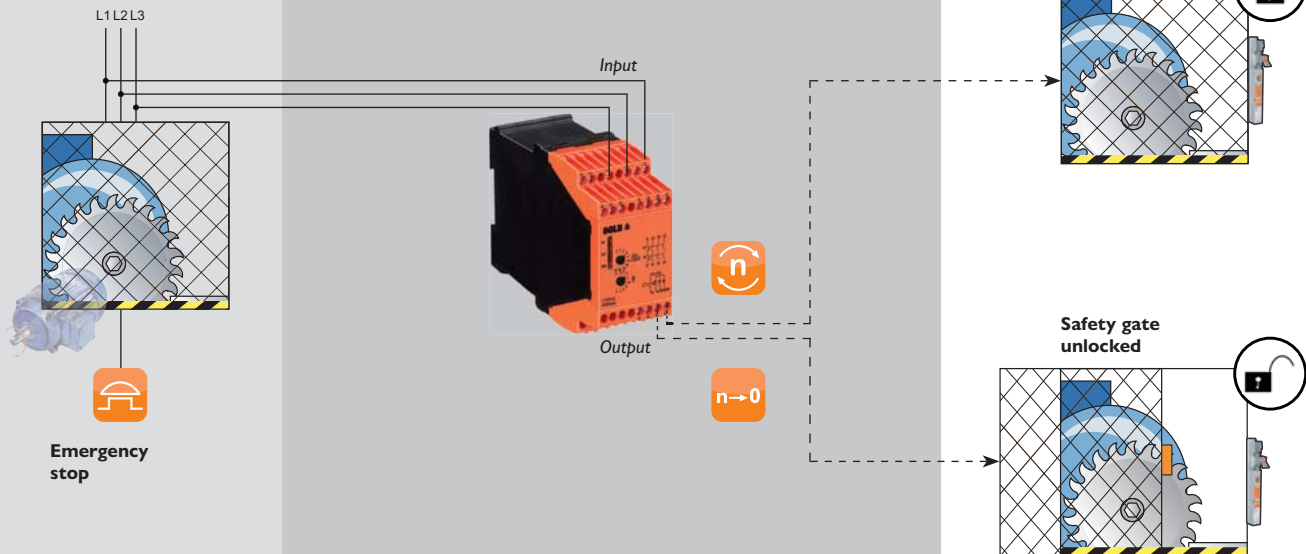

Further information

LH 5946

Start

Are you looking for **safe monitoring of speed and standstill** by means of initiators and encoder?

UH 5947

www.dold.com

DOLD

E. Dold & Söhne GmbH & Co. KG
 Bregstraße 18 • D-78120 Furtwangen
 T +49 7723 654-0 • F +49 7723 654-356
 dold-relays@dold.com • www.dold.com



SAFEMASTER C

DOLD

Multifunctional safety module UG 6970

Safety technology has never been this simple.

The **multifunctional safety module UG 6970** from the **SAFEMASTER C** family serves the protection of staff and machinery by releasing and interrupting safety circuits. Up to two independent safety functions which are selected in a simple way and without programming via latching rotary switches can be implemented in a single device. The flexible adjustment of the safety functions lead to a sustainable reduction in storage costs.

Besides safety functions such as emergency stop, protective door, non-equivalent safety sensor, two-hand or light barrier, it also allows you to connect your safety-related mats and safety edges. The variable start configuration which can also be adjusted via rotary switches, allow for an optimal adjustment in accordance with the application. Besides the manual and automated start, the mutual manual start can also be selected for both safety functions.

With its width of 22.5 mm, the multifunctional safety module UG 6970 supplies two N/O contacts and one semiconductor monitoring output for each safety function.

In accordance with the requirements, the number of safety contacts can be multiplied via the related extension module UG 6929 or the combine extension module UG 6912.28.

Your advantages

- ▶ **Two safety functions independent from each other selectable**
 - Emergency stop
 - Safety gate
 - Two-hand control
 - Safety-mat / safety edge
 - Light barrier
 - Antivalent safety sensor
- ▶ Two safety functions at the same time and a width of 22.5 mm
- ▶ Manual or automated start, individually or jointly

Our experience. Your safety.

Multifunctional safety module UG 6970

Technical features

- ▶ Complies with
 - Performance Level (PL) e and category 4 in accordance with EN ISO 13849-1: 2008
 - Safety Integrity Claim Limit 3 (SIL CL) 3 according to IEC/EN 62061
 - Safety Integrity Level (SIL) 3 according to IEC/EN 61508 and IEC/EN 61511
- ▶ In accordance with EN 50156-1 for furnace installations
- ▶ Line fault detection at the start button
- ▶ Activation via start button or automatic start, joint start possible
- ▶ With or without cross fault detection
- ▶ 2-channel design
- ▶ Forcibly guided output contacts
- ▶ Output: 2 contacts per safety function
- ▶ 1 semiconductor monitoring output per safety function
- ▶ LED displays operating voltage, safety function 1, 2 and faults
- ▶ Pluggable terminal blocks for fast device change
 - screw terminals
 - cage clamp terminals
 - double cage clamp terminals
- ▶ Sealable transparent cover
- ▶ Width 22.5 mm





SAFEMASTER C - UG 6970
2 individual selectable safety functions

Application

A complex plant can be secured and monitored with only 2 devices!

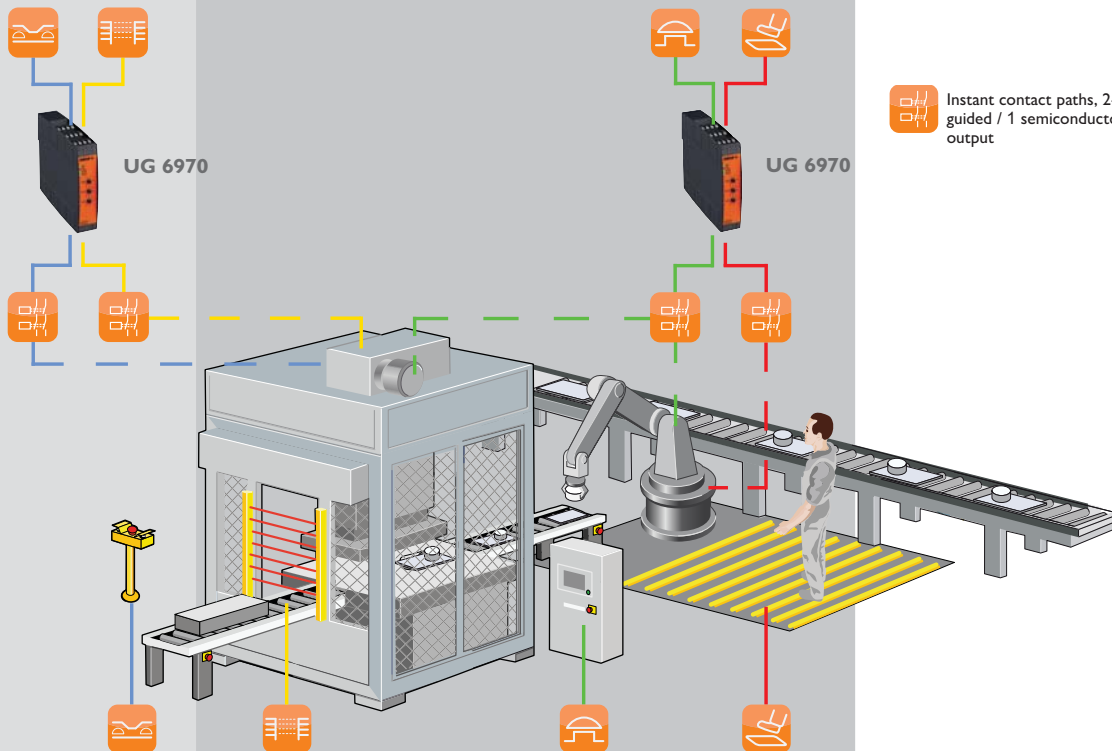
The figure shows a packaging plant with assembly robot and compactor. The compactor can be operated via two-hand control and is additionally secured by a light barrier. The safety-mat deactivates the feed conveyor and the robot, the compactor remains active. The superordinate emergency stop circuit deactivates all release circuits at the same time.



 Instant contact paths, 2-channel, forcibly guided / 1 semiconductor monitoring output

Application examples

- ▶ Machinery and plant engineering
- ▶ Paper and printing industry
- ▶ Automotive industry
- ▶ Recycling industry
- ▶ and many more ...

Further information

UG 6970

Start 

www.dold.com

DOLD 

E. Dold & Söhne GmbH & Co. KG
Bregstraße 18 • D-78120 Furtwangen
T +49 7723 654-0 • F +49 7723 654-356
dold-relays@dold.com • www.dold.com



SAFEMASTER C

DOLD 

Multifunctional safety timer UG 6960

Flexible in function, variable in time

The **multifunctional safety timer UG 6960** from the **SAFEMASTER C** family serves the protection of staff and machinery by releasing and interrupting safety circuits. The UG 6960 combines safety time functions and safety functions in one device. Five different time functions with delay times of up to 300 minutes can be implemented, and selected flexibly and without programming via latching rotary switches. Besides safety functions such as emergency stop, protective door, non-equivalent safety sensor, two-hand or light barrier, it also allows you to connect your safety-related safety-mats and safety edges. The fine adjustment of time which is also done gradually via latching rotary switches is particularly advantageous for an optimal adjustment of the device in accordance with your application.

With its construction width of 22,5 mm, the multifunctional safety timer UG 6960 supplies two N/O contacts and one semiconductor monitoring output each, delayed and undelayed. In accordance with the requirements, the number of safety contacts can be multiplied via the related extension module UG 6929 or the combined extension module UG 6912.28.

Your advantages

▶ **Fast and exact adjustment of different time functions**

- Release delay
- Release delay can be retriggered
- Response delay
- Fleeting on make/fleeting on break
- Detent adjustment of delay time

▶ **Suitable for several safety functions**

- Emergency stop
- Safety gate
- Two-hand control
- Safety-mat / safety edge
- Light barrier
- Antivalent safety sensor

Our experience. Your safety.

Multifunctional safety timer UG 6960

Technical features

- ▶ Complies with
 - Performance Level (PL) e and category 4 in accordance with EN ISO 13849-1: 2008
 - Safety Integrity Claim Limit 3 (SIL CL) 3 according to IEC/EN 62061
 - Safety Integrity Level (SIL) 3 according to IEC/EN 61508 and IEC/EN 61511
- ▶ In accordance with EN 50156-1 for furnace installations
- ▶ Line-fault detection at the start button
- ▶ Activation via start button or automatic start
- ▶ With or without cross fault detection
- ▶ 2-channel design with digital timer
- ▶ Forcibly guided output contacts
- ▶ Output: 2 N/O contacts instant contacts and 2 N/O contacts delayed
- ▶ 1 semiconductor monitoring output for instant contacts
- ▶ 1 semiconductor monitoring output for delayed contacts
- ▶ LED displays operating voltage, safety function, time delay and faults
- ▶ Pluggable terminal blocks for fast device change
 - screw terminals
 - cage clamp terminals
 - double cage clamp terminals
- ▶ Sealable transparent cover
- ▶ Width 22.5 mm





SAFEMASTER C - UG 6960
safe time and safety functions
feasible

Application

Implementation of emergency stop and time control at the same time with only one device!

The figure shows a cartoning plant with a packaging robot. After switching off the feed conveyor, the cartoning unit continues running until the outfeed belt is completely empty. The required time interval can be adjusted in a fast and easy way on the UG 6960. The superordinate emergency stop circuit is implemented via the safety-mat and deactivates all release circuits when stepped on.

-  Instant contact paths, 2-channel, forcibly guided / 1 semiconductor monitoring output
-  Time-controlled, 2-channel, forcibly guided / 1 semiconductor monitoring output

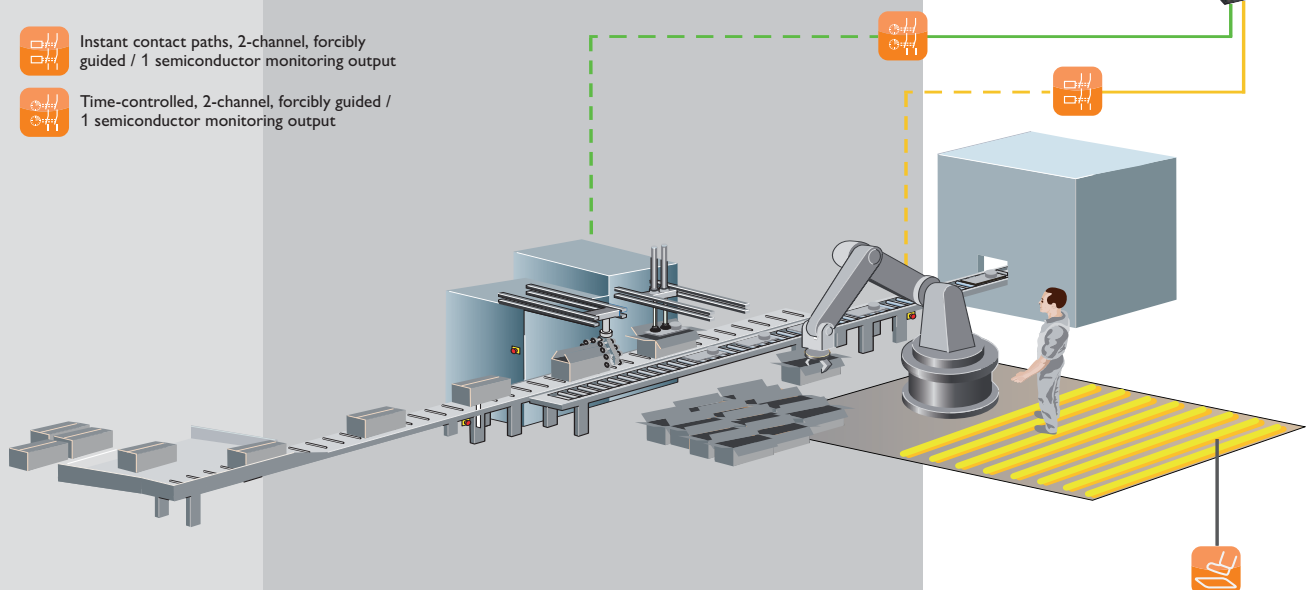

Further information

UG 6960

Start 

www.dold.com

DOLD 

E. Dold & Söhne GmbH & Co. KG
Bregstraße 18 • D-78120 Furtwangen
T +49 7723 654-0 • F +49 7723 654-356
dold-relays@dold.com • www.dold.com



SAFEMASTER M

The modular, software-free safety system

Safety-oriented control systems to evaluate safety switches and sensors as well as for the activation of actors have long been on the market. As a machine and equipment manufacturer, you are spoiled for choice. Hard wire, configure or program? The use of programmable safety controls is not always worth it. The requirements and expenses for software specification, programming, validation and documentation cannot be overlooked.

DOLD offers an interesting alternative with the **multifunctional safety system SAFEMASTER M**, just for smaller to medium sized facilities. Safety requirements are implemented quickly and easily through the software-free configuration.

To configure your safety applications, SAFEMASTER M requires nothing more than a simple screwdriver: Connect safety modules together with ease using a ribbon cable, define the safety function using a rotary switch, and use a DIP switch to assign the safety-related inputs to the outputs and thereby to different safety zones – that's all.

Advantages and customer benefit

- ▶ Multifunctional, modular, freely configurable
- ▶ Free assignment of input and output functions
- ▶ Easy software-free configuration
- ▶ Modular expandability with input and output modules
- ▶ Diagnosis using LEDs and semiconductor outputs
- ▶ Easy function selection with rotary switch
- ▶ Optional fieldbus connection

DOLD 

Our experience. Your safety.

Software-free safety system

Technical features

- ▶ Up to 26 single-channel or 13 2-channel input circuits
- ▶ Up to 15 redundant, safety output contacts
- ▶ 4 start button-inputs for enabling / acknowledgement
- ▶ 2 Semiconductor monitoring output in each input module and control unit
- ▶ 1 input for a feed back circuit in output module each
- ▶ Manual / Auto-Start
- ▶ With / without cross fault detection
- ▶ System indication via optional field bus interface
- ▶ 4 output groups operated either separately, together or individually combined



Minimal configuration







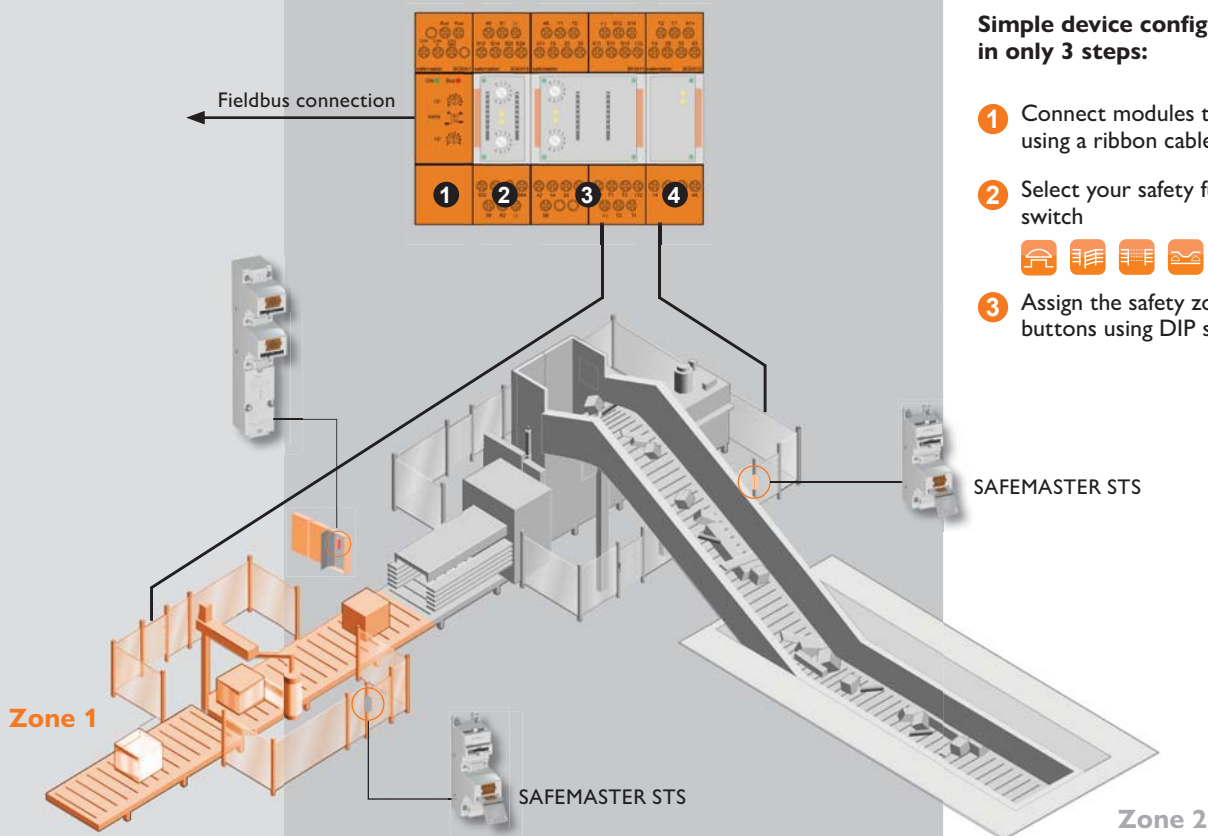

Maximum configuration

Example of application

This example shows a concrete example of a baling press plant. Here, multiple safety zones can be set individually, because not every dangerous situation must invariably lead to the shutdown of the entire system. Thus the conveyor unit of the packaging machine may continue to run when one zone is shut down.



Simple device configuration in only 3 steps:

- 1 Connect modules together using a ribbon cable 
- 2 Select your safety function by rotary switch





- 3 Assign the safety zone and start buttons using DIP switches

- 1 Fieldbus module
- 2 Input module
- 3 Control unit
- 4 Output module

Further information

SAFEMASTER M

Start 

www.dold.com

DOLD



E. Dold & Söhne GmbH & Co. KG
 Bregstraße 18 • D-78120 Furtwangen
 T +49 7723 654-0 • F +49 7723 654-356
 dold-relays@dold.com • www.dold.com



SAFEMASTER PRO

DOLD 

Configurable safety system - Modular and multifunctional

With the size of the plants and complexity of the safety requirements the number of safety devices increases in many applications. In addition logical functions need to be implemented when e.g. only parts of the whole system needed to be disconnected. The modular and **configurable safety system SAFEMASTER PRO** of DOLD monitors the safety circuits of your machines and plants simple, flexible and safe. The number of inputs and outputs of the central control unit can be amended by extension modules. In this way SAFEMASTER PRO can be configured very flexible to the actual application.

The configuration of the TUEV approved system is done very simple on a PC with the free configuration software **SAFEMASTER PRO Designer**: Select safety functions, assign in and outputs and connect them comfortably by PC. Finally transfer the tested logic via USB cable to the safety controller. Ready!

Your advantages

- ▶ For safety applications up to Cat 4 / PL e and SIL 3
- ▶ TÜV certified hardware and software
- ▶ Configuration instead of wiring with SAFEMASTER PRO Designer
- ▶ Simple handling by Drag & Drop in the graphic programming tool
- ▶ Time and cost saving set-up
- ▶ Reduces wiring and saves space in the cabinet
- ▶ Flexible extension with safe I/O modules
- ▶ Safe remote I/Os with bus extender modules for longer distances
- ▶ Extensive failure localisation and diagnostics
- ▶ Memory card as option for simple maintenance

Our experience. Your safety.

Configurable safety system

Technical features

- ▶ Compact design: Control Unit and Extension modules only 22.5 mm width
- ▶ Max. 128 safe inputs and 16 dual-channel or 32 single-channel safety related outputs
- ▶ In addition to the Controller unit max. 14 extension modules can be connected
- ▶ Flexible safety logic to create and amend the safety functions
- ▶ Safe integrated logic testing
- ▶ Monitoring outputs, status LEDs and field bus connection to provide best diagnostic functions
- ▶ TÜV and UL approval



Now also with safe speed monitoring!

System components



Control unit

- ▶ 8 safety inputs
 - ▶ 4 single-channel (/080) or 2 dual-channel safety outputs (OSSD)
 - ▶ Individual programmable restart condition of the feedback circuit for each output
 - ▶ Configuration via PC by Mini USB port
- UG 6911.10 Art.-No. 0063818
UG 6911.12/080 Art.-No. 0068574



Input/Output modules

- ▶ 8 safety inputs
 - ▶ 4 single-channel (/080) or 2 dual-channel safety outputs (OSSD)
 - ▶ Individual programmable restart condition of the feedback circuit for each output
- UG 6916.10 Art.-No. 0063819
UG 6916.12/080 Art.-No. 0068590



Input modules

- ▶ 8, 12 or 16 safety inputs
- UG 6913.08 Art.-No. 0063820
UG 6913.12 Art.-No. 0064865
UG 6913.16 Art.-No. 0063821



Output modules OSSD

- ▶ 2 or 4 dual-channel safety outputs (OSSD)
 - ▶ Individual programmable restart condition of the feedback circuit for each output
- UG 6912.02 Art.-No. 0063822
UG 6912.04 Art.-No. 0063823



Output modules relay

- ▶ 1 or 2 dual-channel safety relay outputs for relay contact extension of the OSSDs
 - ▶ 4 independent single-channel safety relay outputs
 - ▶ Individual programmable restart condition of the feedback circuit for each output
- UG 6912.14 Art.-No. 0063824
UG 6912.28 Art.-No. 0063825
UG 6914.04 Art.-No. 0066057



Bus Extender

- ▶ Decentralization of safe inputs/outputs up to 50 m with up to 6 decentralized module groups
- UG 6918 Art.-No. 0064866



Fieldbus modules

- ▶ Fieldbus modules (Gateways) for extensive diagnostics:
- | | |
|-------------------------|------------------|
| UG 6951 (CANopen) | Art.-No. 0063828 |
| UG 6952 (PROFIBUS DP) | Art.-No. 0063826 |
| UG 6954 (PROFINET) | Art.-No. 0064861 |
| UG 6955 (Ethernet/IP) | Art.-No. 0064862 |
| UG 6956 (EtherCAT) | Art.-No. 0064863 |
| UG 6957 (USB) | Art.-No. 0064864 |
| UG 6958 (Modbus TCP/IP) | Art.-No. 0068268 |
| UG 6959 (Modbus RTU) | Art.-No. 0068270 |

Further information

SAFEMASTER PRO

Start

www.dold.com

Configuration instead of wiring with SAFEMASTER PRO Designer

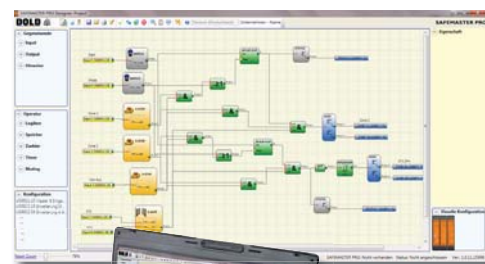

Mini USB-Port



Simple configuration in only 3 steps:

- 1 Select and configure safety functions
- 2 Assign in- and outputs and connect them comfortably on the PC
- 3 Test safety logic and transfer it via USB cable to the safety module - ready!

DOLD

E. Dold & Söhne GmbH & Co. KG
Bregstraße 18 • D-78120 Furtwangen
T +49 7723 654-0 • F +49 7723 654-356
dold-relays@dold.com • www.dold.com



SAFEMASTER W

DOLD 

Wireless emergency stop system - Work wirelessly

In automated manufacturing systems, safety devices ensure that the operator does not come too close to the hazardous area during automatic operation. Frequently, however, operators must work in hazardous areas in special machine operating modes during reviews, programming, or maintenance. In such situations, the **wireless emergency stop system** from the **SAFEMASTER W** family by DOLD offers the safety you need. It is the wireless solution for mobile applications in extended or complex facilities with hazardous zones.

With the wireless emergency stop system, you can safely be closer to what's happening. Besides the safety function, the handheld transmitter has a button and switch which can be freely configured for user-specific control tasks for convenient operation. Independent of the user's location, it facilitates secure operation and makes it possible to switch off facilities in dangerous situations. It can be used universally, providing maximum mobility and safety.

An electronic key allows rights to be allocated to individuals. The optional design of the system with infrared transmitter and infrared receiver serves to securely (re)start machines from pre-defined start zones in the field of view.

Advantages and customer benefit

- ▶ Maximum mobility and flexibility with the highest level of security
- ▶ For security applications up to cat. 4 / PL e or SIL CL 3, TÜV certified
- ▶ Ergonomic handheld transmitter for fatigue-free work
- ▶ Comfortable one-handed operation
- ▶ Maximum freedom of movement due to the cordless design
- ▶ 2-stage push button with tactile switching points
- ▶ Clearly arranged control panel, can be configured individually
- ▶ Protection from accidentally pressing the button
- ▶ Quick charging and high capacity transmitter battery

Our experience. Your safety.

Wireless emergency stop system

Technical features

- ▶ Safe transmission path
- ▶ User-friendly, compact handheld transmitter
 - For wireless safety module BI 5910
- ▶ Comfortable, one-handed operation
- ▶ Available if desired with 4 freely configurable buttons or knobs for control functions
- ▶ With tactile switching points for the 2-stage button
- ▶ With label fields beside the buttons
- ▶ Protection from accidentally operating the buttons
- ▶ Quick charging and high capacity transmitter battery
- ▶ Possible to quickly adjust frequency
- ▶ Optional belt or chest bag for the handheld transmitter

Safety technology characteristics

Performance Level (PL) e and category 4 in accordance with EN ISO 13849-1: 2008

Safety Integrity Level (SIL 3) in accordance with IEC/EN 61508



Wireless safety module
BI 5910



Handheld transmitter
RE 5910



Infrared receiver
(as option)

Order information

Standard type: BI 5910.22/00MF9 DC 24 V
Item number: 0059002

Standard type: RE 5910/001
Item number: 0060610

Examples of application

This example of application shows the wireless emergency stop system SAFEMASTER W in combination with the safety switch and key transfer system SAFEMASTER STS. If the handheld transmitter is removed from the station and started, the wireless emergency stop and additional control functions activate (1). After activating the wireless emergency stop, access to the safety door is granted by SAFEMASTER STS (2) as soon as dangerous movements (3) have been switched off.

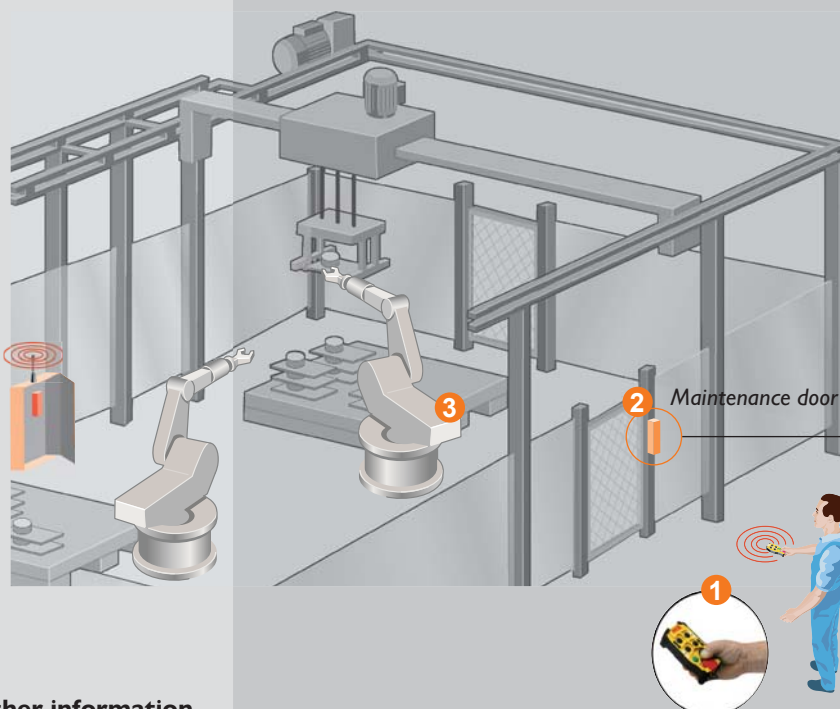

Areas of application

- ▶ Extended mobile danger zones
- ▶ Fully automated fork lifts
- ▶ Gantry cranes
- ▶ Automated high-bay warehouses
- ▶ Robotic cells
- ▶ Automated assembly lines

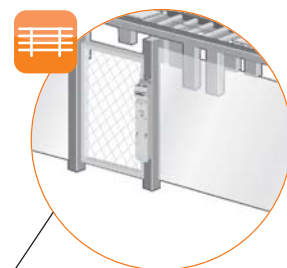

SAFEMASTER STS

Further information

SAFEMASTER W

Start

www.dold.com

DOLD

E. Dold & Söhne GmbH & Co. KG
Bregstraße 18 • D-78120 Furtwangen
T +49 7723 654-0 • F +49 7723 654-356
dold-relays@dold.com • www.dold.com



SAFEMASTER W

Wireless enabling switch - Have a good grip on safety

In automatised processes safety systems block the access to dangerous areas. Often people have to work inside a dangerous area while the machine is in a special operation mode e.g. during test, programming and maintenance.

Especially for these situations the TUEV approved 3-step radiocontrolled **enabling switch SAFEMASTER W** provides the necessary safety functions. It allows a safe operation and safe disconnection in a dangerous situation. It is designed for universal usage and allows maximum mobility and flexibility. In the case of danger the operator presses the button fully or releases it from middle position. The machine goes into safe state. In addition the unit has a display and 4 programmable push buttons to actuate up to 20 control functions. This allows to adopt the device to the actual application. The ergonomic designed enabling switch with large display provides a comfortable one hand operation.

Your advantages

- ▶ Maximum mobility and flexibility at highest safety
- ▶ For safety applications up to Cat 4 / PL e or SIL CL 3, TUEV approved
- ▶ Individual configurable push buttons for up to 20 control functions
- ▶ Ergonomic transmitter for non-tiring operation
- ▶ Comfortable one-hand operation
- ▶ Clear operating panel with easy to read display
- ▶ Fast frequency adaption to environment on the enabling switch
- ▶ Maximum freedom of movement due to wireless design
- ▶ High operating safety by dynamic and redundant data transmission protocol

DOLD 

Our experience. Your safety.

Wireless enabling switch

Technical specification

- ▶ System components of SAFEMASTER W
 - wireless enabling switch RE 6910 (transmitter)
 - radio controlled safety module BI 6910 (receiver)
 - charger station for enabling switch (RE 6910/010)
- ▶ Up to 3 infrared receivers to define starting areas (as option)
- ▶ Radio controlled safety module BI 6910
 - to receive e-stop and control signals via radio transmission
 - to connect e-stop buttons, gate contacts or light curtains
 - safety output contacts:
 - 3 NO or 2NO and 1 NC and 6 transistor outputs for control functions
 - manual and automatic start
 - 3 transistor outputs and LEDS for status indication

Safety related data

Cat 4 / PL e to DIN EN ISO 13849-1
 Safety Integrity Level (SIL 3) to IEC/EN 61508

Ordering data

Standard type: RE 6910/001
 Item number: 0062631

Standard type: BI 6910.22/00MF9 DC 24V
 Item number: 0062571

Applications

- ▶ Setup and maintenance of robot cells
- ▶ Entering machine working areas during setup
- ▶ Maintenance of dangerous machines
- ▶ Manual interfering in automatic processes
- ▶ Maintenance of automated storage systems
 ...and for all applications with access to dangerous areas. **Please contact us**

Functions (Function mode)



Further information

RE 6910

Start

www.dold.com



Enabling switch RE 6910 and charger



Infrared receiver (as option)

Some setting possibilities at a glance:

- ▶ Configuration of push buttons
- ▶ Assigning push buttons to outputs
- ▶ Individual programmable display text
- ▶ Frequency adoption to ambient requirements
- ▶ Adjustment of radio signal strength
- ▶ Blocking of push buttons

DOLD

E. Dold & Söhne GmbH & Co. KG
 Bregstraße 18 • D-78120 Furtwangen
 T +49 7723 654-0 • F +49 7723 654-356
 dold-relays@dold.com • www.dold.com



SAFEMASTER W

Radio controlled safety system UH 6900 - In pair mode

DOLD 

The safety approved, bidirectional **radio controlled safety system UH 6900** from the **SAFEMASTER W series**, is for the transmission of safety inputs such as E-stop and conventional control functions and offers great flexibility for the protection of hazardous areas. By implementing the latest radio controlled technologies, a high level of safety and a long transmission range is achieved. Two safety zones can easily be connected wirelessly over a considerable distance. The main application areas include applications covering large areas and mobile applications such as fully automated conveyor systems and driverless transport systems. Simple and inexpensive retrofitting of existing safety systems can also be achieved wirelessly with this system.

The device allows connection of up to 3 two-channel safety transmitters (E-stop, LC, safety gate, two-hand, etc.), simple configuration, and comprehensive sampling and diagnostic options.

With the radio controlled safety system, you will have an automated safety solution that can be integrated wirelessly into various applications. The option to select between three operating modes (complete protected mode, cross mode, protected mode with connectable ratio control) allows the device to be quickly and reliably adapted to your individual application.

Advantages and customer benefit

- ▶ For safety applications up to Cat. 4 / PL e or SIL 3, TÜV certified
- ▶ Safety approved, bidirectional E-stop transmission
- ▶ Long transmission range up to 800 m
- ▶ Quick start, fast set-up procedure
- ▶ Reliable data transmission with superior interference suppression
- ▶ Comprehensive error indication and diagnostics
- ▶ Two channel safety inputs / outputs
- ▶ Control inputs / outputs
- ▶ Integrated analysis of existing on site radio networks



Our experience. Your safety.

Radio controlled safety system UH 6900 - Pair mode

Technical features

- ▶ Complies with
 - Performance Level (PL) e and category 4 acc. to EN ISO 13849-1
 - SIL Limit (SIL CL) 3 acc. to IEC/EN 62061
 - Safety Integrity Level (SIL) 3 acc. to IEC/EN 61508 and IEC/EN 61511
- ▶ Machine directive 2006/42/EC
- ▶ 3 different operating modes selectable
- ▶ Connect 3 two-channel safety functions, depending on operating mode:
 - E-stop, safety door, LC, two hand, 1 start button
- ▶ Single safety output with 3 contact paths
- ▶ 8 semi-conductor inputs and outputs for control functions
- ▶ Semi-conductor outputs to signal radio reception, status display
- ▶ Different frequency ranges possible:
 - 433 / 869 MHz (EU version), 915 MHz (US version)
- ▶ LEDs for status display
- ▶ 45 mm width



Radio controlled safety module UH 6900

Order information

Standard type: UH 6900.03PS / 00MF0 DC 24 V / 433 MHz
Item number: 0067213

Overview

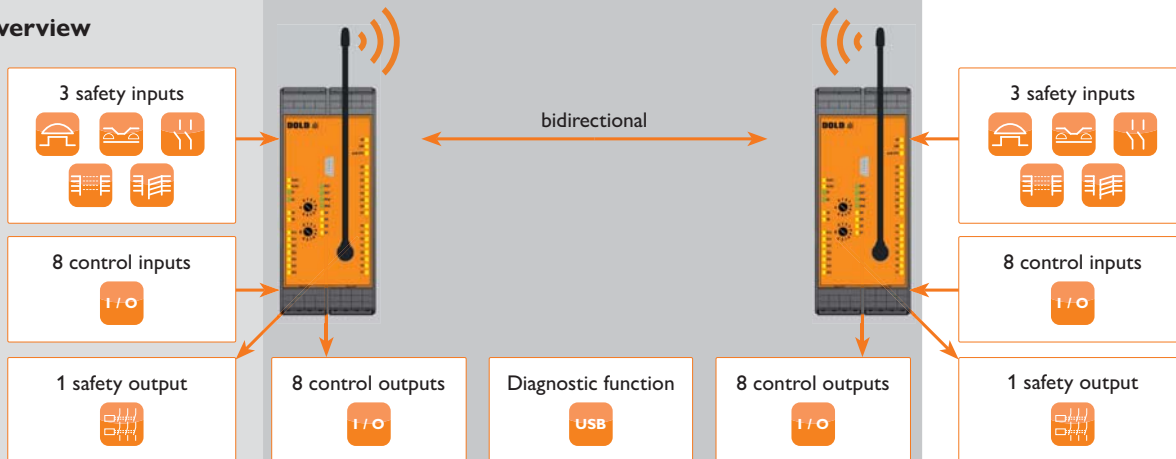

Application example

The application example shows, safe, wireless protection of automated machinery and systems of large physical size.

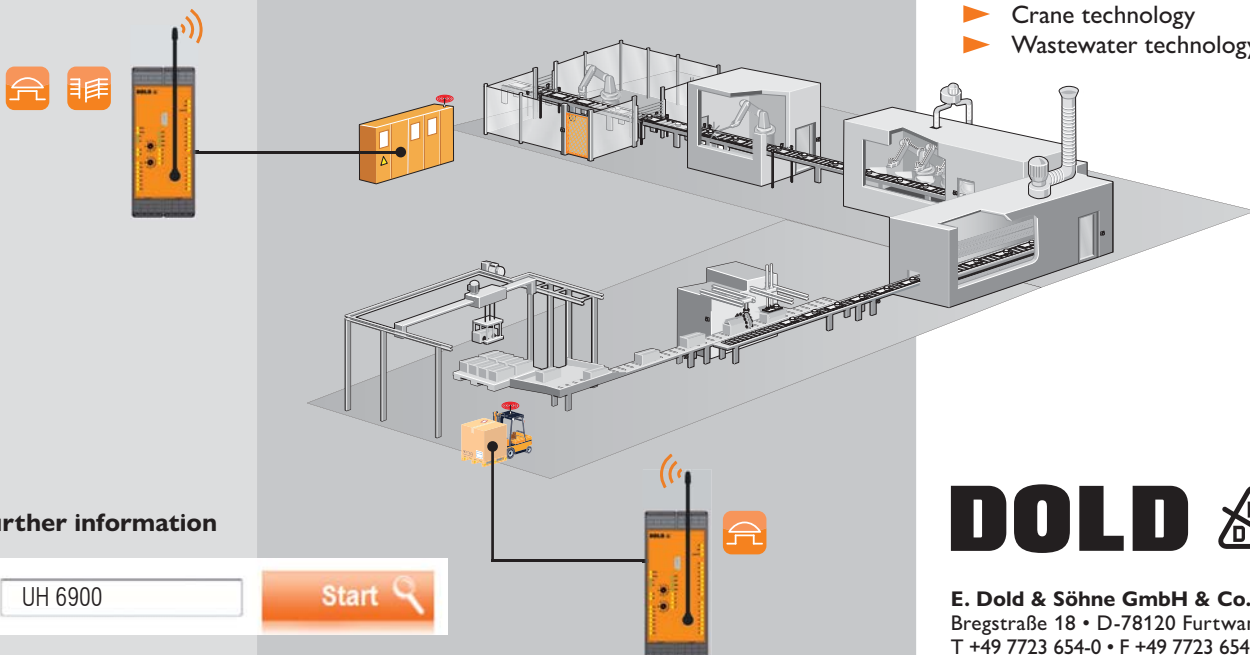

Application

- ▶ Fully-automated floor-level conveyors
- ▶ Automated guided vehicle systems
- ▶ High-bay warehouses
- ▶ Transport conveyors
- ▶ Crane technology
- ▶ Wastewater technology

Further information

UH 6900

Start

www.dold.com

DOLD

E. Dold & Söhne GmbH & Co. KG
Bregstraße 18 • D-78120 Furtwangen
T +49 7723 654-0 • F +49 7723 654-356
dold-relays@dold.com • www.dold.com



SAFEMASTER W

Radio controlled safety system UH 6900 - In group mode

The **radio controlled safety system UH 6900** of the **SAFEMASTER W** series, consisting of one group controller and up to 255 group receivers for the safety-related, wireless transmission of emergency stop and control functions, offers more flexibility in safeguarding hazardous areas. By implementing the latest radio controlled technologies, a high level of safety and a long transmission range is achieved. With the group controller, several receivers can be safely switched off via a unidirectional, safety-related radio link. Furthermore, the controller can exchange message, control and status information with a receiving device.

The devices enable the connection of up to 3 two-channel safety sensors (emergency stop, LC, safety door, two-hand etc.) and offer simple configuration as well as extensive evaluation and diagnostic options.

The main areas of application include mobile applications such as fully automated floor conveyors and driverless transport systems. A simple and cost-effective retrofitting of existing safety systems can also be realized without wiring.

Advantages and customer benefits

- ▶ For safety applications up to Cat. 4 / PL e or SIL 3, TÜV certified
- ▶ Safety-related, unidirectional emergency-stop transmission in group mode
- ▶ Long transmission range up to 800 m
- ▶ Quick start, fast set-up procedure
- ▶ Reliable data transmission and low susceptibility to interference
- ▶ Comprehensive fault localization and diagnosis
- ▶ Two-channel safety inputs / outputs
- ▶ Control inputs / outputs
- ▶ Integrated analysis of the existing radio network

DOLD



PL e
SIL 3

800 m



Our experience. Your safety.

Radio controlled safety system UH 6900 - Group mode

Technical features

- ▶ According to
 - Performance Level (PL) e and Category 4 acc. to EN ISO 13849-1
 - SIL Limit (SIL CL) 3 acc. to IEC/EN 62061
 - Safety Integrity Level (SIL) 3 acc. to IEC/EN 61508 and IEC/EN 61511
- ▶ Machinery Directive 2006/42/EC
- ▶ Connection of 3 two-channel safety functions: Emergency stop, safety door, LC, two-hand, 1 start button
- ▶ 1 signal output with 3 contact paths (group controller)
- ▶ 1 safety output with 3 contact paths (receiver)
- ▶ 8 semiconductor inputs and outputs for control functions
- ▶ Semiconductor outputs for signalling radio reception, status display
- ▶ Different frequency ranges possible:
 - 433 / 869 MHz (EU version), 915 MHz (US version)
- ▶ 45 mm width



Radio controlled safety module UH 6900
Group controller



Radio controlled safety module UH 6900
Group receiver

Order information

Standard type: UH 6900.03PS / 00GC0 DC 24 V / 433 MHz
Item number: 0067955 (Group controller)

Standard type: UH 6900.03PS / 00GR0 DC 24 V / 433 MHz
Item number: 0067957 (Group receiver)

Overview

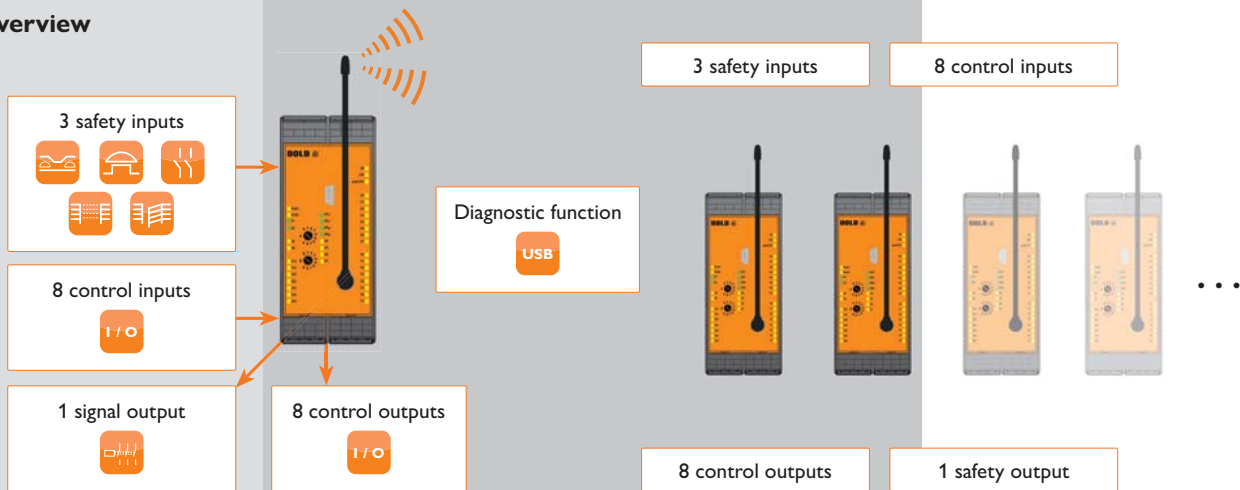

Application example

If a safety function (e.g. emergency stop, etc.) is triggered on the group controller, all group receivers are switched off in a safety-related manner.

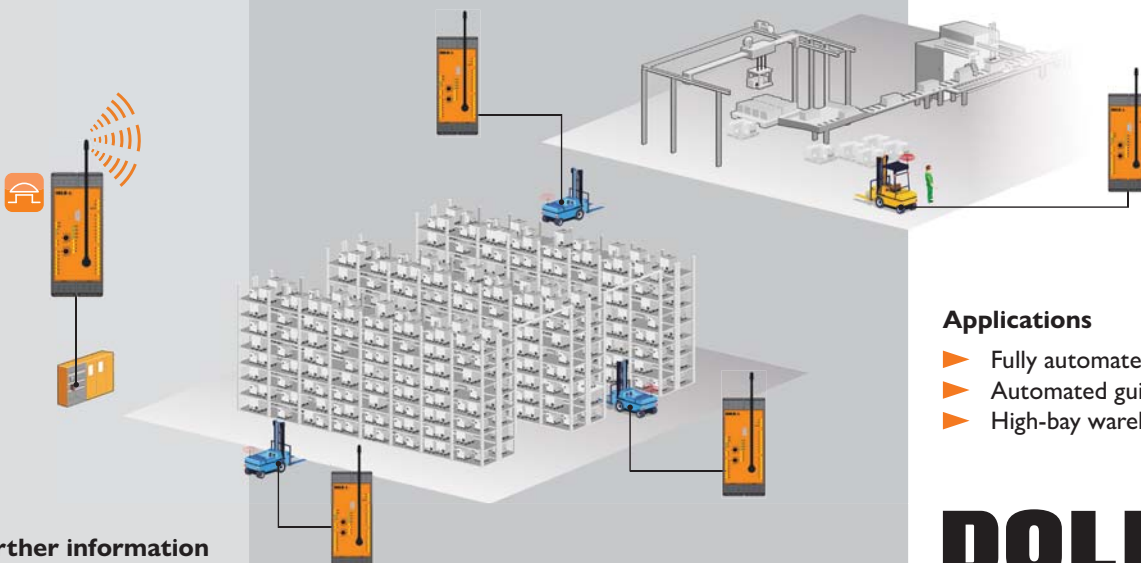

Applications

- ▶ Fully automated floor conveyors
- ▶ Automated guided vehicle systems
- ▶ High-bay warehouses

Further information

UH 6900

Start

www.dold.com

DOLD

E. Dold & Söhne GmbH & Co. KG
Bregstraße 18 • D-78120 Furtwangen
T +49 7723 654-0 • F +49 7723 654-356
dold-relays@dold.com • www.dold.com



VARIMETER EDS

Insulation fault location system with Modbus RTU -
Precise localisation of faults during operation

DOLD 

In extensive industrial systems, the localisation of insulation faults can be a cost-intensive and time-consuming process. The **insulation fault location systems** from the **VARIMETER EDS** family of DOLD, comprising the **RR 5886** test current generator and the **RR 5887** insulation fault location device, localise insulation faults quickly and reliably in complex insulated AC/DC mains (IT systems).

A device for insulation fault detection, also known as IFLS (Insulation Fault Location System), enables the rapid localisation of insulation faults in non-earthed power supply systems. It is employed along with an insulation monitor and in the event of a fault it injects a test current between the current-carrying conductors and the earth. It allows the quickest possible localisation of components with pre-existing insulation damage so that they can be replaced before a complete failure occurs, i.e. there is no need to shut down the plant. Protective devices such as circuit breakers or fuses only trip after a second fault. Immediate fault rectification is therefore required.

During operation you receive all necessary information regarding faulty circuits and consumer outputs, which can be visualised directly on the RR 5887 insulation fault detection device. Via the Modbus RTU interface, insulation fault current values can be read out from the connected devices. This allows the optimum planning of the maintenance and repair of your plant. VARIMETER EDS is suitable for use in a great variety of sectors.

Advantages and customer benefits

- ▶ Automatic and rapid localisation of faulty circuits
- ▶ Increase in reliability and system availability
- ▶ Optimum planning of the maintenance and repair
- ▶ No manual and time-consuming fault detection
- ▶ Simple operation
- ▶ Monitoring of complex systems
- ▶ With Modbus RTU interface

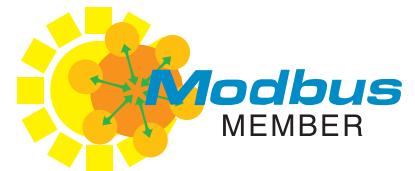

Our experience. Your safety.

Insulation fault location system

Technical features

- ▶ Insulation fault detection in AC, DC and AC/DC mains (IT systems) per: DIN EN 61557-9 (VDE 0413-9):2009 and DIN EN 61557-1 (VDE 0413-1)
- ▶ Modbus RTU
- ▶ Status output for insulation fault detection via external switch output
- ▶ 105 mm installation width

RR 5886

- ▶ External control possible via insulation monitor
- ▶ Button for manual test current output
- ▶ Terminal connection for automatic test current output

RR 5887

- ▶ Connection of max. 4 or 8 differential current transformers
- ▶ Manual or automatic reset selectable via jumper Y1-Y2
- ▶ Button for manual resetting of alarm conditions
- ▶ Terminal connection for saving alarm conditions



Test current generator
RR 5886



Insulation fault location device
RR 5887



Differential current transformer
ND 5017/024

Order information

Standard type: RR 5886 AC/DC 85 ... 230 V
Item number: 0068220

Standard type: RR 5887.12 AC/DC 85 ... 230 V
Item number: 0068221

Standard type: ND 5017/024
Item number: 0066017

Application

Devices for insulation fault location can be particularly advantageous when dealing with complex and ramified power supply systems. Computer centres, which are operated using non-earthed mains (IT systems) for reasons of availability and interference immunity, can also benefit from the use of an insulation fault location system. It allows the quickest possible localisation of components with pre-existing insulation damage so that they can be replaced before a complete failure occurs. Faulty circuits and consumer outputs can be visualised directly on the insulation fault location device RR 5887 and can be read out via the Modbus RTU interface.

Application areas

- ▶ Power stations
- ▶ Shipbuilding
- ▶ Transportation technology
- ▶ Industrial systems
- ▶ Hospitals

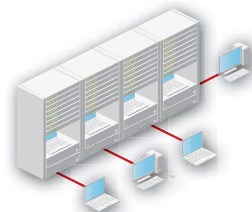

IFLS

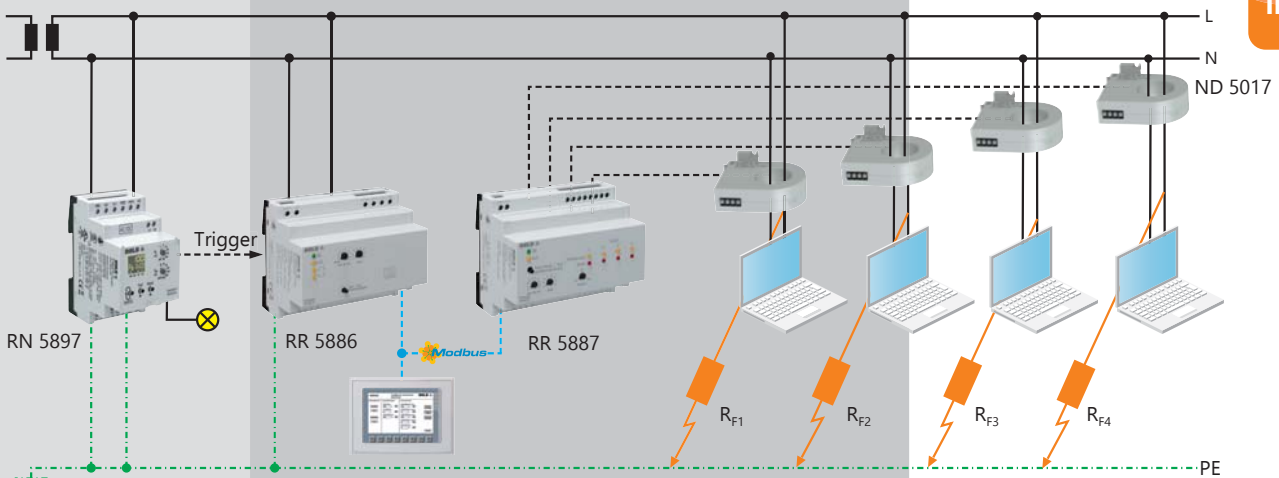

Further information

RR 5886

Start

www.dold.com

DOLD

E. Dold & Söhne GmbH & Co. KG
Bregstraße 18 • D-78120 Furtwangen
T +49 7723 654-0 • F +49 7723 654-356
dold-relays@dold.com • www.dold.com



VARIMETER RCM

Residual current monitor RN 5883 - Reliably detect fault currents

DOLD

The **residual current monitor RN 5883** (type B) from the **VARIMETER RCM** family by DOLD detects fault currents with DC or AC components in earthed networks. Here, the differential current measurement is implemented via the ND 5015 external differential current transformer. With an installation depth of 71 mm, the RN 5883 is also suitable for use in installation consumer units and industrial cabinets.

Residual current monitors (RCMs) measure and monitor differential currents or fault currents in earthed power supply systems. They are installed in systems in which a message rather than a shut-down is to be initiated in the event of a fault. In comparison to residual current breakers (or residual current devices - RCDs), which trip in the event of a defined fault current being measured and cause an immediate shut-down, residual current monitors indicate a fault current early and report a degradation of insulation via an output contact for example.

The early detection of insulation faults along with preventative maintenance and repair outside operating hours allows unexpected downtimes for machines and systems to be avoided and this in turn avoids undesirable operational interruptions, property damage and high costs.

Advantages and customer benefits

- ▶ Space-saving switch cabinet installation with a width of just 52.5 mm
- ▶ Time and cost optimised maintenance / repair
- ▶ High system availability through early fault reporting
- ▶ Simple adjustment via stepped rotary switches
- ▶ Broken wire detection in the measurement circuit
- ▶ 4 measurement ranges from 10 mA to 3 A
- ▶ Adjustable pre-alarm

Our experience. Your safety.

Residual current monitor RN 5883

Technical features

- ▶ Acc. to IEC/EN 62 020, VDE 0663
- ▶ For AC and DC systems Type B, acc. to IEC/TR 60755
- ▶ For detection of insulation faults in earthed networks
- ▶ 4 measurement ranges from 10 mA ... 3 A
- ▶ Alarms and pre-alarms with manual reset possible
- ▶ With adjustable switching delay
- ▶ Energized or de-energized on trip selectable
- ▶ LED display for operation, pre-alarm and alarm
- ▶ With test function
- ▶ Display via LED chain for differential current
- ▶ With analogue output as an option
- ▶ Broken wire detection
- ▶ Adjustment protection for the rotary switch with transparent cover which can be lead-sealed
- ▶ 52.5 mm installation width



Residual current monitor
RN 5883



Residual current transformer
ND 5015

Order information

Standard type: RN 5883.12/61 AC/DC 80 ... 230 V
Item number: 0066451

Standard type: ND 5015/035/61
Item number: 0066841

Areas of application

- ▶ Co-generation plants
- ▶ Medical facilities
- ▶ Battery and UPS systems
- ▶ Laboratory facilities
- ▶ Printing machines



Application examples

The differential current measurement is implemented via an external differential current transformer. All power lines of the output (without PE) to be protected are routed through the transformer. In a fault-free network the sum of all currents will be zero, so no voltage will be induced in the differential current transformer. However, if an insulation fault results in a fault current flowing to earth, the current difference in the transformer will induce a current which will be detected and evaluated by the RN 5883. In the event of the threshold value being exceeded, the device switches to alarm condition and the LEDs for the pre-alarm and alarm flash.

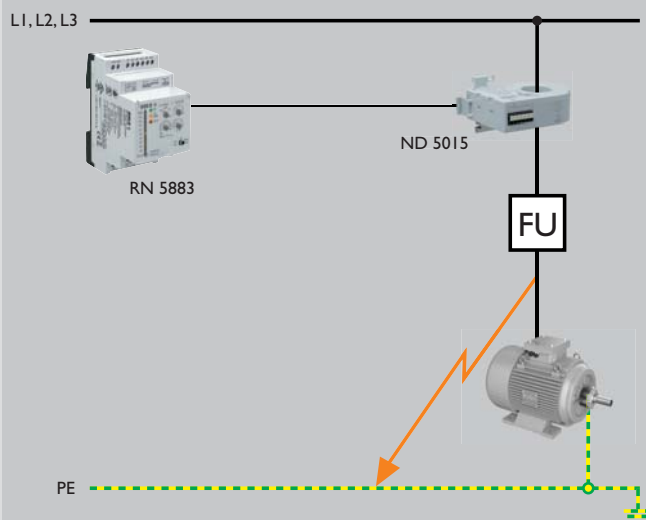

Further information

RN 5883

Start

www.dold.com

DOLD

E. Dold & Söhne GmbH & Co. KG
Bregstraße 18 • D-78120 Furtwangen
T +49 7723 654-0 • F +49 7723 654-356
dold-relays@dold.com • www.dold.com



VARIMETER RCM

Split current transformer ND 5014 - Quick mounting, easy to retrofit

The new **split current transformers ND 5014** from the **VARIMETER RCM** series are suitable for residual current monitoring in conjunction with the **residual current monitor IL 5882**, for both alternating and pulsating direct currents in earthed mains. By opening the current transformers, they can be easily mounted on the conductors of the output to be monitored, thus enabling simple installation in existing plants or retrofitting measures. The split mechanism eliminates the need to cut or disconnect the conductors, thus minimizing costly interruptions to operation. Especially as the cutting of the conductors can lead to the fact that a new approval may have to be carried out for the plant. The compact current transformers are available in 3 sizes with a feed-through opening of \varnothing 49, 79 and 119 mm and allow vertical or horizontal mounting to the DIN rail.

The accuracy of a residual current measurement depends not only the quality of the products but also the suitable combination of measuring device and current transformer. DOLD also supplies appropriate residual current monitors for the split current transformer ND 5014. The monitoring devices IL 5882, SL 5882 and IP 5882 of the VARIMETER RCM series are particularly suitable for this purpose. Please do not hesitate to contact us for further information.

Advantages and customer benefits

- ▶ Ideal for retrofitting, no need to cut the conductors
- ▶ Due to split mounting ideally suited for existing plants
- ▶ Quick installation due to split technology
- ▶ High and reliable measuring accuracy up to 30 A
- ▶ Feed-through openings of \varnothing 49, 79 and 119 mm available
- ▶ Reliable connection technology through push-in terminal block
- ▶ Extensive program for residual current monitoring from one source

DOLD 

Our experience. Your safety.

Split current transformer ND 5014

- Technical features**
- ▶ According to IEC 61869-1 and IEC 61869-8
 - ▶ Measurement according to IEC/EN 62020, Type A
 - ▶ Up to 30 A
 - ▶ Vertical and horizontal mounting to the DIN rail
 - ▶ ND 5014/120 also with screw fastening

Order information

Standard type: ND 5014/050 Ø 49 mm
Item number: 0068614

Standard type: ND 5014/080 Ø 79 mm
Item number: 0068613

Standard type: ND 5014/120 Ø 119 mm
Item number: 0068565

- Applications**
- ▶ Railway and traffic technology
 - ▶ Energy supply and distribution
 - ▶ Communication technology equipment
 - ▶ Computer centres and IT facilities
 - ▶ Building and electrical installation technology

Wiring

The hinged cover protects the push-in terminal block and makes unintentional disconnection of the connection wiring more difficult ❶. The removable push-in terminal block facilitates the mounting of the transformer ❷. The stripping length of the conductors is 10 mm and the connection capacity is 0.2 ... 2.5 mm² ❸.

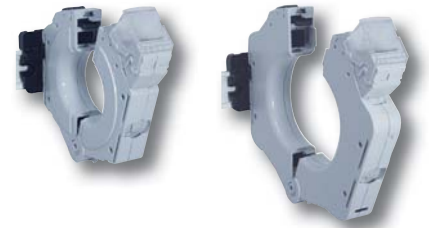
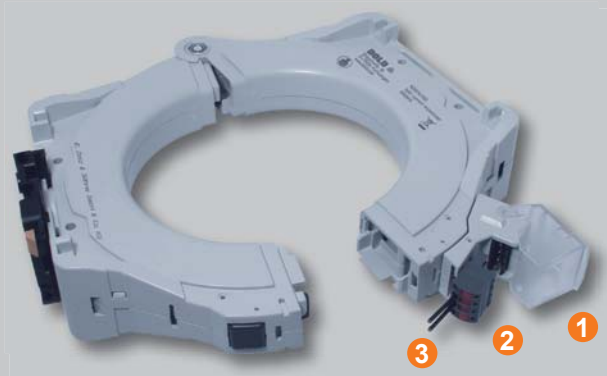

ND 5014/050
Ø 49 mm

ND 5014/080
Ø 79 mm



ND 5014/120
Ø 119 mm

Suitable residual current monitors



IL 5882
Distribution enclosure
63 mm installation depth
35 mm width



SL 5882
Switch cabinet enclosure
100 mm installation depth
35 mm width



IP 5882
Distribution enclosure
63 mm installation depth
70 mm width
Cage clamp terminals
forcibly guided contacts



Further information

ND 5014

Start

Do you need further current transformers
for residual current monitoring?

ND 5016

www.dold.com

DOLD

E. Dold & Söhne GmbH & Co. KG
Bregstraße 18 • D-78120 Furtwangen
T +49 7723 654-0 • F +49 7723 654-356
dold-relays@dold.com • www.dold.com

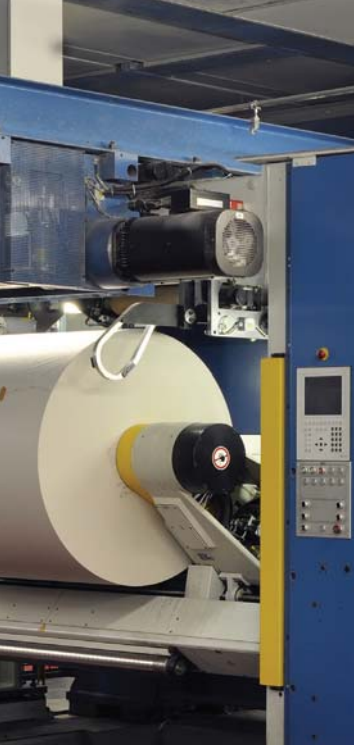

VARIMETER IMD

Insulation Monitor LK 5894

DOLD 

With the new **Insulation Monitor LK 5894** from the **VARIMETER IMD** family, DOLD offers a convincing solution for insulation monitoring of non-earthed AC, AC/DC, and DC power supplies (IT systems). The LK 5894 increases the availability of plants and is used for preventive maintenance and repair. Faults are detected even during operation and costly plant standstills are prevented. The insulation monitor was specially designed for use in modern power supplies that often include rectifiers, converters, thyristor controllers or directly connected DC components. EMC interference suppression measures with its leakage capacitances against earth play an important role in this matter. DOLD's insulation monitor meets the criteria.

Besides a faster fault localisation by selective earth fault detection and optimised measuring times, the insulation monitor can deal with system leakage capacitances of up to 1000 μF . It is also universally applicable in non-earthed DC/AC and mixed networks from 0 V to 690 V nominal voltage. The maximum voltage can be up to DC 1000 V and AC 760 V without additional adaption device.

The device can be adjusted quickly and easily with its latching rotary switches. The measuring circuit monitoring for broken wire detection and the LED chain for indication of the current insulation resistance are further convincing features of the LK 5894.

Advantages and customer benefit

- ▶ Preventive fire and plant protection
- ▶ Early insulation fault detection during operation
- ▶ No additional adaption device needed
- ▶ Fast error localisation via selective earth fault detection to L+ and L-
- ▶ Suitable for universal application in non-earthed DC/AC and mixed networks
- ▶ Suitable for system leakage capacitances up to 1000 μF
- ▶ Simple adjustment via latching rotary switches
- ▶ Reliable monitoring, also in voltage-free network
- ▶ Measuring circuit monitoring of wire breakage

Our experience. Your safety.

Insulation Monitor LK 5894

Technical features

- ▶ Insulation monitoring in accordance with IEC/EN 61557-8
- ▶ Detection of symmetrical and asymmetrical insulation faults
- ▶ 2 changeover contacts
- ▶ Max. voltage up to DC 1000 V and AC 760 V
- ▶ Adjustment range prewarning threshold: 20 k Ω ... 2 M Ω
- ▶ Adjustment range alarm threshold: 1 k Ω ... 250 k Ω
- ▶ Open circuit or closed circuit principle selectable for output relay
- ▶ Adjustment of maximum system leakage capacitance for reduction of response time
- ▶ Simple, clearly structured setting of the device with screw driver
- ▶ LED chain for indication of the current insulation resistance
- ▶ Display „measurement circuit active“
- ▶ Automated and manual device self test
- ▶ Construction width 90 mm



Insulation monitor
LK 5894

Order information

Standard type: LK 5894.12/010 DC 20 ... 30 V
Item number: 0065331

Fields of application

- ▶ DC / AC and mixed IT networks
- ▶ UPS systems
- ▶ Networks with frequency converters
- ▶ Battery networks
- ▶ DC driven networks
- ▶ Hybrid cars or battery operated cars

Accessories



Buzzer
RK 8832

Application

The application example illustrates an insulation monitor with current indication of the insulation resistance in an IT system. When a first insulation fault occurs, a warning or alarm is displayed. When a second insulation fault occurs, fuses or circuit breakers will shut down the plant.

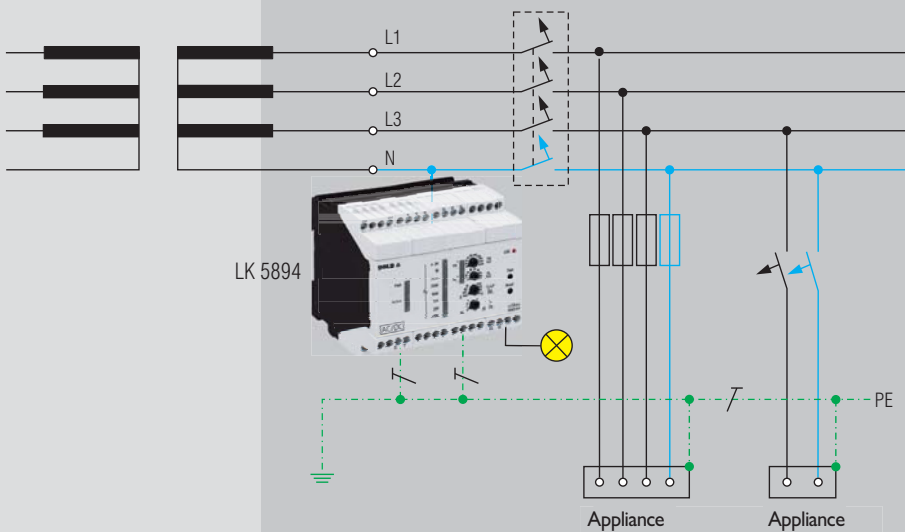

Principle of a non-earthed IT system with insulation monitoring

M11202_b

Further information

LK 5894

Start

Do you have **leakage capacities up to 3000 μ F**, do you need a **second additional measuring circle or analogue output** ?

LK 5896

www.dold.com

DOLD

E. Dold & Söhne GmbH & Co. KG
Bregstraße 18 • D-78120 Furtwangen
T +49 7723 654-0 • F +49 7723 654-356
dold-relays@dold.com • www.dold.com



VARIMETER IMD

DOLD 

Insulation Monitor LK 5895 / LK 5896

With the new **Insulation Monitors LK 5895** and **LK 5896** from the **VARIMETER IMD** family, DOLD offers a convincing solution for insulation monitoring of non-earthed AC, AC/DC, and DC power supplies (IT systems). The devices increase the availability of plants and are used for preventive maintenance and repair. Faults are detected even during operation and costly plant standstills are prevented. The insulation monitors were specially designed for use in modern power supplies that often include rectifiers, converters, thyristor controllers or directly connected DC components. EMC interference suppression with its leakage capacitances against earth plays an important role in this matter. The two insulation monitors meet these requirements.

Besides a faster fault localisation by selective earth fault detection and optimised measuring times, the insulation monitors can deal with system leakage capacitances of up to 3000 μF . They are also universally applicable in non-earthed DC/AC and mixed networks from 0 V to 1000 V nominal voltage. The maximum voltage is up to DC 1500 V and AC 1100 V without additional adaption device. An additional measurement circuit allows simultaneous monitoring of an AC network which is galvanically isolated from the main measurement circuit. Universal analogue outputs for the insulation resistance output complete the device's functionality.

Advantages and customer benefit

- ▶ Preventive fire and plant protection
- ▶ Early insulation fault detection during operation
- ▶ No additional adaption device needed
- ▶ Fast error localisation via selective earth fault detection to L+ and L-
- ▶ Suitable for universal application in non-earthed DC/AC and mixed networks
- ▶ Suitable for large-scale system leakage capacitances up to 3000 μF
- ▶ Simple adjustment via latching rotary switches
- ▶ Reliable monitoring, also in voltage-free network
- ▶ LK 5896 with additional measurement circuit

Our experience. Your safety.

Insulation Monitor LK 5895 / LK 5896

Technical features

- ▶ Insulation monitoring in accordance with IEC/EN 61557-8
- ▶ Detection of symmetrical and asymmetrical insulation faults
- ▶ Measurement circuits can be switched off via control terminals, e.g. in case of network connection
- ▶ 1 changeover contact each for prewarning and alarm
- ▶ 3. Output relay to indicate broken wire and device faults
- ▶ Max. voltage up to DC 1500 V and AC 1100 V
- ▶ Adjustment range prewarning threshold: 20 kΩ ... 2 MΩ
- ▶ Adjustment range alarm threshold: 1 kΩ ... 250 kΩ
- ▶ Open circuit or closed circuit principle selectable for output relay
- ▶ Adjustment of maximum system leakage capacitance to reduce response time
- ▶ LED chain for indication of the current insulation resistance
- ▶ Indication of active measurement circuits
- ▶ Automated and manual device self test
- ▶ Manual or auto alarm reset selectable
- ▶ External test and reset buttons can be connected
- ▶ Construction width 90 mm



Insulation monitor
LK 5896

Accessories



Buzzer
RK 8832



Indicating instrument
RP 5898

Order information

Standard type: LK 5895.12/010 DC 20 ... 30 V
Item number: 0065217

Standard type: LK 5896.13/100 DC 20 ... 30 V
Item number: 0065131

Application

With its two measurement circuits, i.e. the main measurement circuit and the additional measurement circuit, the insulation monitor LK 5896 is perfectly suitable for photovoltaic systems. While the main measurement circuit monitors the DC side for insulation faults in front of the inverter, the insulation resistance against earth can be analysed on the AC side by means of the additional measurement circuit. And this is done prior to connection to the photovoltaic system. In order to prevent a reciprocal influence of both measurement circles, the additional measurement circuit is deactivated via control terminal when connecting the system.

Fields of application

- ▶ Non-earthed DC/AC and mixed IT networks
- ▶ UPS systems
- ▶ Networks with frequency converters
- ▶ Battery networks
- ▶ DC driven networks
- ▶ Photovoltaic systems
- ▶ Hybrid cars or battery operated cars

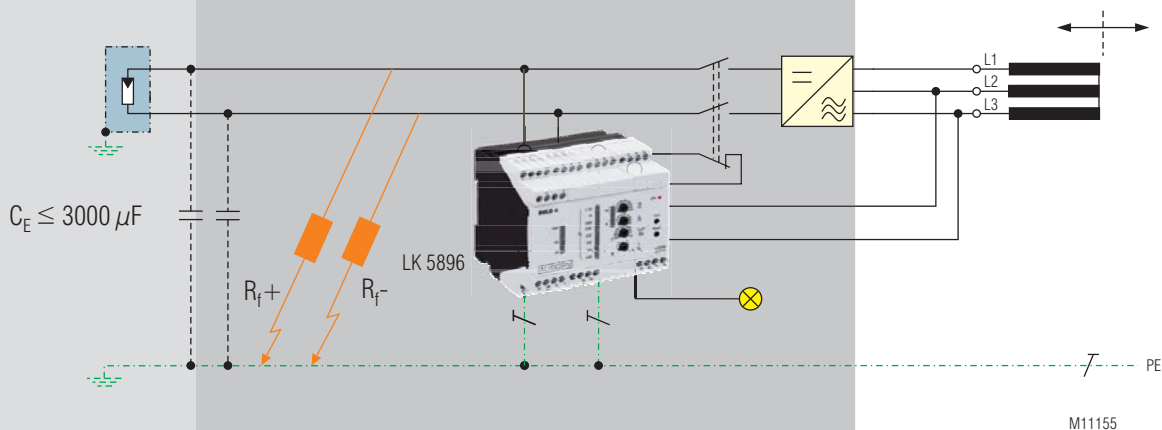

Principle of a non-earthed IT system with insulation monitoring also after the inverter, before connection

Further information

LK 5896

Start

You need a device for
system leakage capacitances
up to 1000 μF?

LK 5894

www.dold.com

DOLD

E. Dold & Söhne GmbH & Co. KG
Bregstraße 18 • D-78120 Furtwangen
T +49 7723 654-0 • F +49 7723 654-356
dold-relays@dold.com • www.dold.com



VARIMETER IMD

Insulation monitor RN 5897/020 - Insulation monitoring for DC charging stations

DOLD 

The number of electric vehicles is constantly increasing and will grow even faster in the future. This will also drive forward the expansion of the charging station infrastructure, as DC charging stations are the first choice when electric vehicles need to be charged in the shortest possible time. Electrical safety must be guaranteed during the charging process. For this purpose, an unearthed DC power supply system (IT grid) with insulation monitoring is set up and monitored by means of an insulation monitoring device (IMD). The user must never be exposed to high voltages (up to 1000 V) at any time.

The **insulation monitor RN 5897/020** of the **VARIMETER IMD** family is used especially for DC charging stations according to the IEC/EN 61851-23:2014/AC:2016-06 standard and monitors the charging process from the charging station into the vehicle. The device is characterised by the short response delay of ≤ 1 s, a rated voltage up to DC 1000 V with coupling device and the detection of asymmetrical as well as symmetrical insulation faults. The integrated voltage measurement ensures reliable detection of the insulation resistance in the IT grid. The insulation monitor also features a self-test. This takes place automatically after power-on and after every full operating hour.

Advantages and customer benefits

- ▶ Response delay of ≤ 1 s
- ▶ Nominal voltage up to DC 1000 V
- ▶ Integrated voltage metering
- ▶ Self-test function after every full operating hour
- ▶ Detection of symmetrical and asymmetrical insulation faults
- ▶ Fast fault localization through selective earth fault detection according to L+ and L-
- ▶ Multicolour display for indication of insulation value
- ▶ Universally applicable in unearthed AC, DC and AC/DC grids
- ▶ Simple setting of parameters via rotary switch and menu navigation

Our experience. Your safety.

Insulation monitor RN 5897/020

Technical features

- ▶ Suitable for DC charging stations for electric vehicles according to IEC/EN 61851-23:2014/AC:2016-06
- ▶ Insulation monitoring according to IEC/EN 61557-8
- ▶ With connection facility for an external coupling device RP 5898 for voltages up to 1000 V
- ▶ 2 separate adjustable response thresholds (using e.g. for pre-alarm and alarm)
- ▶ Adjustment range 1st response value (pre-alarm): 20 k Ω ... 500 k Ω
- ▶ Adjustment range 2nd response value (alarm): 1 k Ω ... 100 k Ω
- ▶ 1 changeover contacts each for insulation failures-pre-alarm and -alarm
- ▶ Energized or de-energized on trip can be selected for indicator relay
- ▶ Multi-coloured display for indication of the current insulation resistance, the device status and for parameter setting
- ▶ Automatic and manual device self-test
- ▶ Alarm storage selectable
- ▶ Manipulation protection through sealable transparent cover
- ▶ External control input for combined test / reset button with additional stop of the measuring function
- ▶ 3 wide voltage ranges for the auxiliary voltage
- ▶ Width 52.5 mm



Insulation monitor
RN 5897/020

Accessories



Coupling device
RL 5898



Coupling device
RP 5898



Buzzer
RK 8832

Order information

Standard type: RN 5897.12/020 DC 12 ... 24 V
Item number: 0068260

Standard type: RN 5897.12/020 AC/DC 24 ... 60 V
Item number: 0068258

Standard type: RN 5897.12/020 AC/DC 85 ... 230 V
Item number: 0068259

Standard type: RP 5898 / RL 5898/61
Item number: 0066944 / 0068315

Application example

The RN 5897/020 offers a standard-compliant solution for monitoring the insulation resistance of DC charging stations. The charging station is fed from an earthed TN-(C)-S system and passes via an isolating transformer into an unearthed IT system. This IT system can be advantageously monitored for insulation faults with the RN 5897/020. When a vehicle is connected to the charging station, the insulation monitor monitors the insulation of the entire system, including the charging station and vehicle.

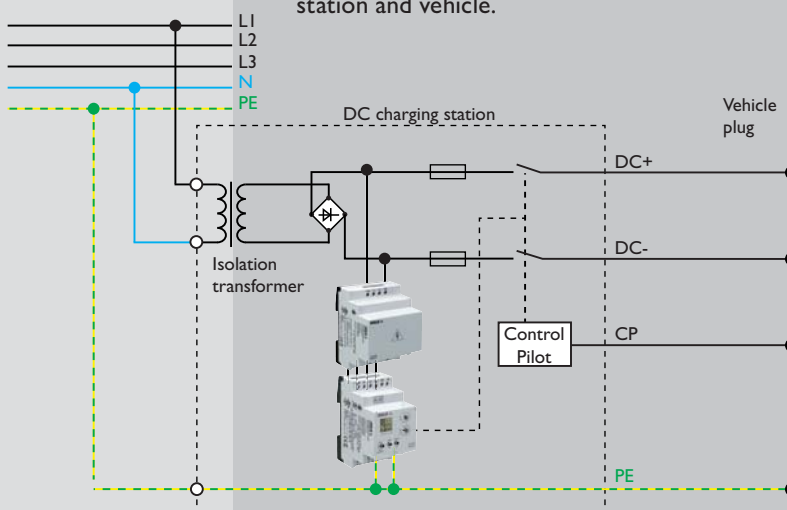

Fields of application

- ▶ UPS systems
- ▶ Unearthed AC, DC, AC/DC mains
- ▶ Mains with frequency converters
- ▶ Battery networks
- ▶ Mobile generators



Further information

RN 5897/020

Start

www.dold.com

Do you need a **communication interface** for the central **evaluation, control and visualisation** of your measurement data?

RN 5897/021

DOLD

E. Dold & Söhne GmbH & Co. KG
Bregstraße 18 • D-78120 Furtwangen
T +49 7723 654-0 • F +49 7723 654-356
dold-relays@dold.com • www.dold.com



VARIMETER IMD

DOLD 

Insulation monitor RN 5897/300 - Safety for mobile generators

The **insulation monitor RN 5897/300** from the **VARIMETER IMD** series by DOLD was developed especially for use with mobile generators. In mobile applications, such as in emergency vehicles or on construction sites, electrical energy must be used to reliably prevent injuries and property damage. Furthermore, mobile generators need to guarantee immediate operational readiness, without requiring time-consuming procedures to set up safeguards (such as installing and calibrating grounding systems, testing RCD, etc.). That's why the safeguard "electrical separation with insulation monitoring and shutdown" is available. It triggers an automated shutdown within < 1 s if the insulation resistance sinks below $100 \Omega / V$, even at extreme temperatures. The RN 5897/300 meets these demands, and fulfills the requirements of DIN VDE 0100-551 for mobile generators.

The insulation monitor is suitable for system leakage capacitance of up to $30 \mu F$, and is designed for universal use in ungrounded AC, DC and AC/DC networks up to 300 V rated voltage. Besides an adjustable alarm threshold, the insulation monitor also has an adjustable pre-alarm threshold. A multicolored LED status light keeps users informed continuously on the current operating status. The device enables reliable monitoring, even in a network without current.

Advantages and customer benefit

- ▶ Increased protection for operators and devices
- ▶ Ready for immediate use
- ▶ No requirement for an electrician to calibrate protective safeguards
- ▶ Wide temperature range from $-40 \dots +70 \text{ }^\circ\text{C}$
- ▶ Multi-color LED device status light to display operational status
- ▶ Easy to adjust parameters with a rotary dial
- ▶ Early recognition of insulation faults

Our experience. Your safety.

Insulation monitor RN 5897/300

Technical features

- ▶ In accordance with DIN VDE 0100-551 for mobile generators
- ▶ Operational temperature range: - 40 ... + 70 °C
- ▶ Trips within < 1 s, if the insulation resistance drops below 100 Ω / V
- ▶ Insulation monitoring in accordance with IEC/EN 61557-8
- ▶ 2 response thresholds which can be set independently (e.g. available for pre-alarm and alarm)
- ▶ Adjustment range 1. Response value (pre-alarm): 20 kΩ ... 1 MΩ
- ▶ Adjustment range 2. Response value (alarm): 10 kΩ ... 250 kΩ
- ▶ 1 changeover each for insulation fault pre-alarm and insulation fault alarm
- ▶ Load or closed current principle adjustable for signaling relay
- ▶ With multi-color LED device status lights to display operational status
- ▶ Automated and manual device self test
- ▶ Selectable alarm memory
- ▶ Manipulation protection through sealed transparent cover
- ▶ External control input for combined Test / Reset button
- ▶ 3 wide voltage ranges for the auxiliary voltage
- ▶ Installation width 52.5 mm



Insulation monitor
RN 5897/300



Accessories



Buzzer
RK 8832

Order information

Standard type: RN 5897.12/300 DC 12 ... 24 V
Item number: 0067252

Standard type: RN 5897.12/300 AC/DC 24 ... 60 V
Item number: 0066942

Standard type: RN 5897.12/300 AC/DC 85 ... 230 V
Item number: 0066943

Examples of application

Monitoring mobile generators with the protective feature “electrical separation with insulation monitoring and shutdown” in accordance with DIN VDE 0100-551. If the insulation resistance falls below the minimum response level (standards require max. 100 Ω / V), the insulation monitor will trip within < 1 s and interrupt the electricity supply through a main switch.

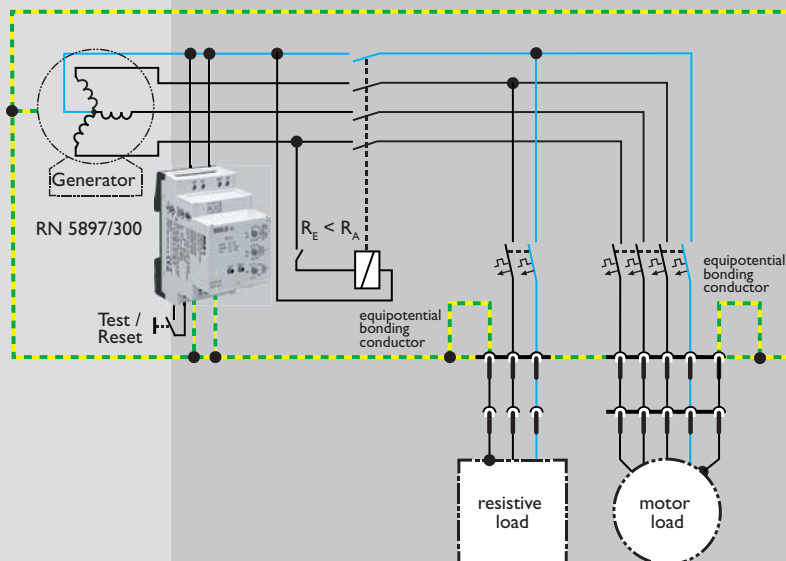

Areas of application

- ▶ Mobile generators
- ▶ UPS systems / battery networks
- ▶ Networks with frequency converters
- ▶ Hybrid and battery-powered vehicles

Further information

RN 5897/300

Start

www.dold.com



DOLD

E. Dold & Söhne GmbH & Co. KG
Bregstraße 18 • D-78120 Furtwangen
T +49 7723 654-0 • F +49 7723 654-356
dold-relays@dold.com • www.dold.com



VARIMETER IMD

Insulation monitor RN 5897/010 - Insulation monitoring for modern IT systems

DOLD 

The demand for the availability of machines and apparatus in the region of factory machinery and process technology is constantly increasing. The requirement for this is a functioning and reliable power supply. Unexpected insulation faults in the system can lead to unwanted power supply failures, and even cause personal injury or property damage. This is why insulation monitoring equipment is typically used in IT systems.

The **insulation monitor RN 5897/010** from the **VARIMETER IMD** series by DOLD was developed especially for use with modern power supplies. These are often comprised of converters, thyristor regulators, and direct current components. Through EMV interference suppression measures, high leakage capacitance onto the ground is present. The RN 5897/010 is suited for system leakage capacitances of up to 1000 μF , and for voltages up to AC/DC 230 V. Using the additional ballast unit RP 5898, it is possible to install the unit in systems with voltages of up to AC 690 V and DC 1000 V.

Besides an adjustable alarm threshold, the insulation monitor also has an adjustable pre-alarm threshold. A multicoloured LCD screen constantly updates stating the current insulation value. The insulation monitors guarantee additional surveillance over current-free networks. A selective earth fault detection of L+ and L- enables quick fault localisation.

Advantages and customer benefit

- ▶ Recognition of symmetrical and asymmetrical insulation faults
- ▶ Quick error localization through selective earth fault detection based on L+ und L-
- ▶ Preventive fire and plant protection
- ▶ Multi-color display to show the insulation value
- ▶ Universal use in ungrounded AC-, DC- and AC/DC networks
- ▶ Suitable for system leakage capacitance of up to 1000 μF
- ▶ Easy to adjust parameters with a rotary dial and menu organization

Our experience. Your safety.

Insulation monitor RN 5897/010

Technical features

- ▶ Insulation monitoring in accordance with IEC/EN 61557-8
- ▶ Standard type RN 5897/010 with option to connect an external ballast unit RP 5898 for voltages up to AC 690 V, DC 1000 V
- ▶ 2 separated, adjustable response thresholds (e.g. can be used for pre-alarm and alarm)
- ▶ Adjustment range
 1. Response value (pre-alarm): 20 kΩ ... 2 MΩ
 2. Response value (alarm): 1 kΩ ... 250 kΩ
- ▶ 1 changeover each for insulation fault pre-alarm and insulation fault alarm
- ▶ Load or closed current principle adjustable for signaling relay
- ▶ Multi-colored display to show the current insulation resistance, the device status, and for setting parameters
- ▶ Setting for maximum system leakage capacitance to shorten response times
- ▶ Automated and manual device self test
- ▶ Selectable alarm memory
- ▶ Manipulation protection through sealed clear cover
- ▶ External control input for combined Test / Reset button
- ▶ 3 wide voltage ranges for the auxiliary voltage
- ▶ Construction width 52.5 mm



Insulation monitor
RN 5897/010



Accessories



Coupling device
RL 5898



Coupling device
RP 5898



Buzzer
RK 8832

Order information

Standard type: RN 5897.12/010 AC/DC 24 ... 60 V
Item number: 0066940

Standard type: RN 5897.12/010 AC/DC 85 ... 230 V
Item number: 0066941

Standard type: RP 5898 / RL 5898/61
Item number: 0066944 / 0068315

Examples of application

Monitoring of a mixed IT network for insulation faults with the RN 5897/010. The insulation monitor is connected to L1 and L2 on the AC side and measures the insulation resistance against PE. If threshold values set on the device (pre-alarm or alarm) are exceeded, this is displayed on the multi-color screen of the RN 5897/010, and the K1 and K2 signaling relays switch on accordingly.

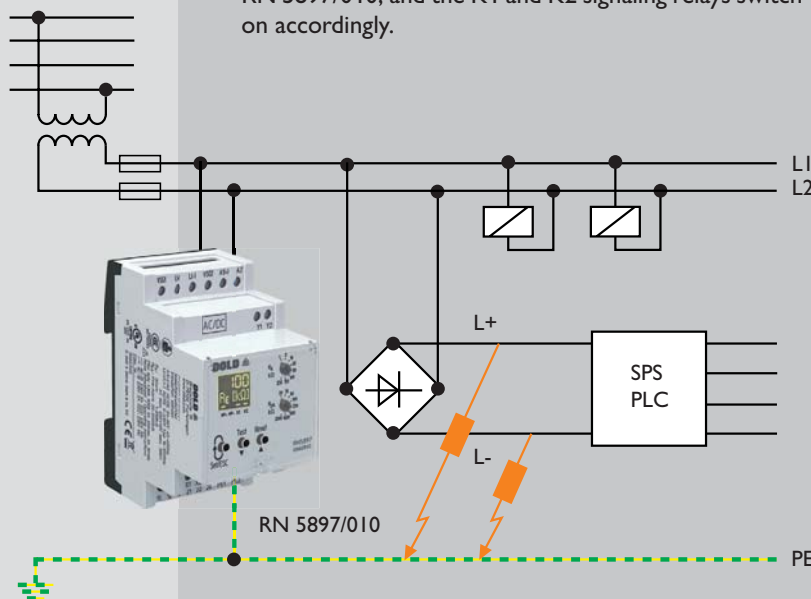

Areas of application

- ▶ UPS systems / battery networks
- ▶ Networks with frequency converters
- ▶ Elevators
- ▶ Hybrid and battery-powered vehicles
- ▶ Mobile generators

Further information

RN 5897/010

Start

www.dold.com

If you have high system leakage capacitances up to 3000 μF, you need a second additional measuring circuit or analog outputs?

LK 5896

DOLD

E. Dold & Söhne GmbH & Co. KG
Bregstraße 18 • D-78120 Furtwangen
T +49 7723 654-0 • F +49 7723 654-356
dold-relays@dold.com • www.dold.com



VARIMETER PRO

DOLD

Multifunction measuring relay UG 9400 - with Modbus RTU

Trouble-free and economic operation of machinery and plant is greatly improved by the reliable and continuous monitoring of single and 3-phase mains. Especially for pumping stations, fan drives and signalling systems where preventive maintenance measures or early fault detection is indispensable. If different parameters have to be monitored simultaneously, the investment, maintenance, operating and installation costs will be increased.

With the **multifunction measuring relay UG 9400** from the **VARIMETER PRO** series, DOLD combines up to 9 monitoring functions in one device with a width of only 22.5 mm and also enables parameterisation and monitoring via Modbus. Depending on the requirements, the UG 9400 can simultaneously monitor the 3-phase mains for overvoltage/undervoltage, voltage unbalance, overcurrent/undercurrent, $\cos \phi$, active, apparent and reactive power, frequency and phase sequence. It can also be used in single-phase mains applications. The compact UG 9400 measuring relay, also has two output relays which can be configured independently for different parameters.

Commissioning, parameter setting and monitoring is quick and easy via a Modbus RTU interface. This fieldbus connection saves wiring and offers extensive diagnostic options, which increase the reliability and availability of machinery and plant. In many applications, the simple integration of Modbus RTU enables cost effective central monitoring of measured electrical variables, especially in applications with complex and extensive plant.

Advantages and customer benefits

- ▶ Central parameter setting, monitoring and diagnostics via Modbus RTU
- ▶ Considerable space saving in the control cabinet due to a width of only 22.5 mm
- ▶ Large measuring ranges 3 phase AC 24 ... 690 V
- ▶ Galvanically separated Modbus RTU interface
- ▶ Simplified stocking due to 9-in-1 unit

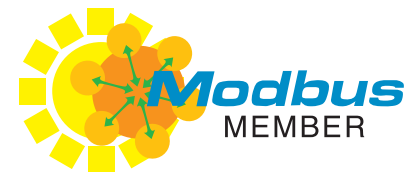

Our experience. Your safety.

Multifunction measuring relay UG 9400

Technical features

- ▶ Multifunction measuring relay acc. to IEC/EN 60255-1
- ▶ With galvanically separated Modbus RTU interface
- ▶ Voltage monitoring (single and 3-phase)
- ▶ Current monitoring
- ▶ Frequency monitoring
- ▶ Power factor $\cos \varphi$
- ▶ Phase sequence, phase failure
- ▶ Voltage / Phase asymmetry
- ▶ Active, reactive and apparent power
- ▶ Start up time delay, response delay
- ▶ Adjustable hysteresis 0.2 ... 50 % of the response value
- ▶ Error memory
- ▶ 2 x independent changeover contacts
- ▶ Settable Relay function energized or de-energized on trip
- ▶ Width 22.5 mm



Multifunction measuring relay
UG 9400



Order information

Standard type:
UG 9400.12PM 3 AC 24 ... 690 V AC 12 A AC/DC 24-240 V
Item number: 0068514

Fields of application

- ▶ Fan drives and pumping stations
- ▶ Signalling and photovoltaic systems
- ▶ Crushing plants and biogas plants

Application example

The example shows the use of the multifunction measuring relay UG 9400 for monitoring an application with different measured variables. Each relay can be assigned up to 9 measured variables. In this example, if the measurement is outside the limit values of voltage or asymmetry, relay 1 switches. If the limit value of $\cos \varphi$ is exceeded, relay 2 switches. Monitoring, parameter setting and diagnostics are performed centrally via the Modbus RTU interface.

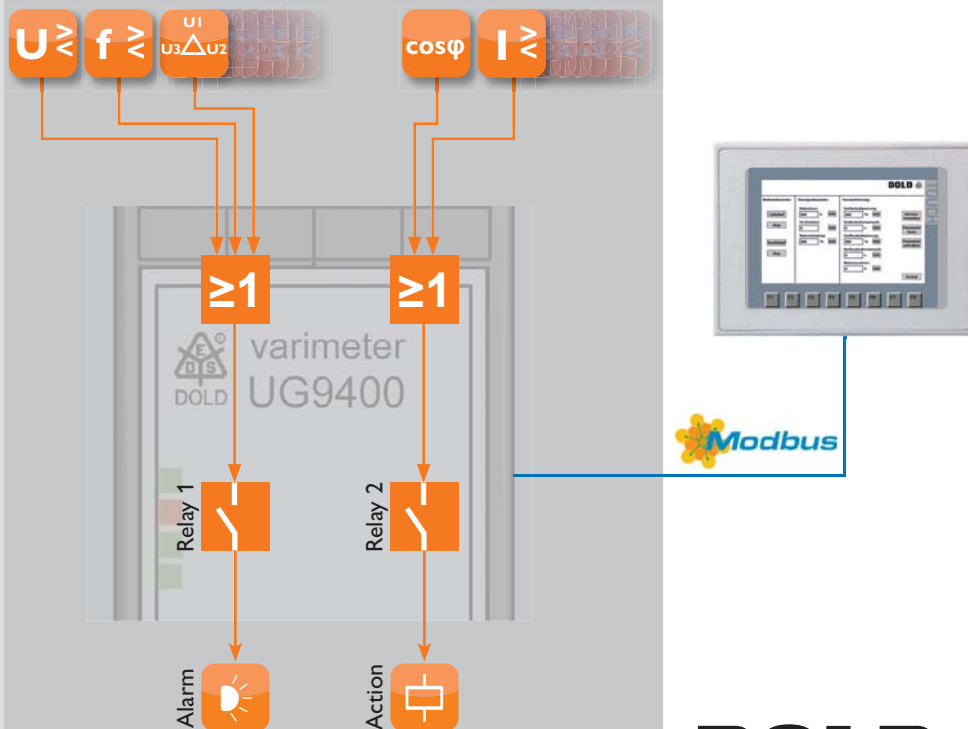

Further information

UG 9400

Start

www.dold.com

DOLD

E. Dold & Söhne GmbH & Co. KG
Bregstraße 18 • D-78120 Furtwangen
T +49 7723 654-0 • F +49 7723 654-356
dold-relays@dold.com • www.dold.com



VARIMETER PRO

Universal measuring relay MK 9300N - One device, many functions

With the **universal measuring relay MK 9300N** of the **VARIMETER PRO** series, DOLD combines up to nine monitoring functions in a housing only 22.5 mm wide. This universal measuring and monitoring relay thus offers a functional diversity unparalleled so far at this minimal unit width.

Troublefree and economic operation of machines and systems is guaranteed only by the reliable and continuous monitoring of three-phase systems. Depending on the need, the VARIMETER PRO therefore monitors the three-phase system simultaneously for overvoltage/ undervoltage, voltage asymmetry, overcurrent/undercurrent, cos phi, active power, apparent power and reactive power, frequency and phase sequence. Employment in single-phase systems is also possible.

To facilitate simple fault diagnostics, this all-rounder features a display and a multicoloured LED. The user-friendly device configuration permits optimal adjustment to the application. For example, the response values for all monitoring functions can be easily set. The space-saving multifunctional measuring relay is optionally equipped with one or two output relays, independently configurable.

Advantages and customer benefit

- ▶ Min-, Max. value or window monitoring
- ▶ Simultaneous monitoring of up to 9 different parameters
- ▶ Simple configuration and fault diagnostic
- ▶ Different fault indications
- ▶ Large measuring range 3 AC 24 ... 690 V
- ▶ Auxiliary voltage ranges DC 24 V, AC 230 V or AC/DC 110 ... 400 V
- ▶ Early detection of irregular states
- ▶ Space and cost saving
- ▶ Reduced wiring

DOLD

Our experience. Your safety.

Universal measuring relay MK 9300N

Technical features

- ▶ Multifunction measuring relay acc. to EN 60255-1, DNV
- ▶ Voltage monitoring (1- and 3-phase)
- ▶ Current monitoring
- ▶ Frequency monitoring
- ▶ Power factor cos phi
- ▶ Phase sequence, phase failure, asymmetry
- ▶ Effective-, reactive- and apparent power
- ▶ Start up delay, on delay
- ▶ Adjustable hysteresis 0.2 ... 50 % of response value
- ▶ Manual reset
- ▶ LCD for indication of the measuring values
- ▶ Relay output
 - MK 9300N: 1 changeover contact
 - MH 9300: 2 x 1 changeover contacts
- ▶ Relay function selectable (energized/de-energized on trip)
- ▶ As option with plugable terminal blocks
 - with screw terminals
 - or with cage clamp terminals
- ▶ MK 9300N: Width 22,5 mm
- ▶ MH 9300: Width 45 mm



Universal measuring relay
MK 9300N



Universal measuring relay
MH 9300

Order information

Standard type:
MK 9300N.11/022 3 AC 24 ... 400 V AC 12 A DC 24 V
Item number: 0063630

Standard type:
MH 9300.12/022 3 AC 24 ... 400 V AC 12 A AC 230 V
Item number: 0063631

Device setting

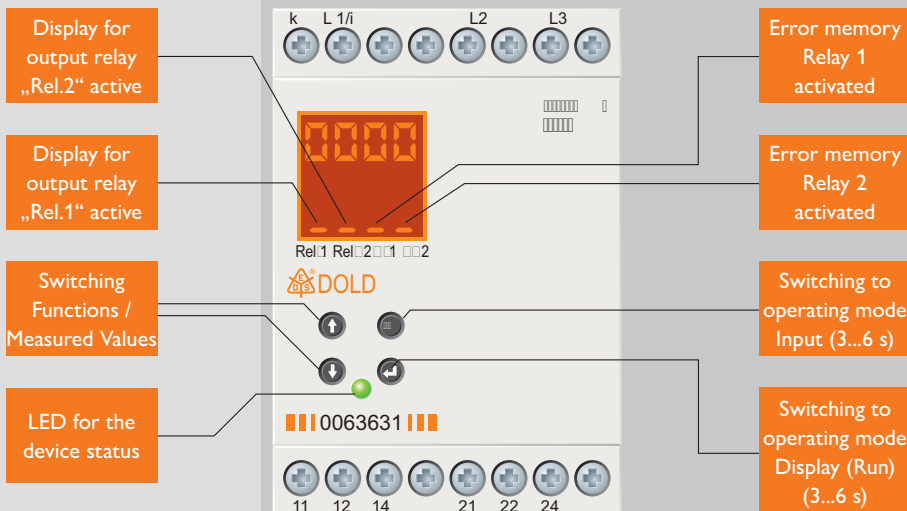

Areas of application

- ▶ Shipbuilding, ports, shipyards
- ▶ Refrigeration lorry
- ▶ Mill drives
- ▶ Fan drives
- ▶ Pumping unit
- ▶ Signal systems
- ▶ Contactor controls
- ▶ Crusher

Further information

MK 9300N

Start

www.dold.com

DOLD

E. Dold & Söhne GmbH & Co. KG
Bregstraße 18 • D-78120 Furtwangen
T +49 7723 654-0 • F +49 7723 654-356
dold-relays@dold.com • www.dold.com



VARIMETER

DOLD 

Measuring and monitoring relays - Now with UL approval

In the field of monitoring electrical parameters, DOLD has added new **measuring and monitoring relays** to its **VARIMETER** family. These have UL approval and are equipped with large measuring ranges, adjustable response values and switching delays as well as hystereses. Versatile functionality, flexible adjustment options and a compact design provide maximum protection for your machines and systems. This allows mains and voltage faults to be detected and rectified at an early stage before major consequential damage occurs.

The measuring relays monitor overvoltage and undervoltage, voltage ranges, phase asymmetry and phase sequence. The measurement functions can be easily selected using rotary switches and without a complicated menu structure. Early detection of impending failures and preventive maintenance prevent costly damage, and as a user you benefit from the operational safety and high availability of your system.

Advantages and customer benefits

- ▶ Simple device adjustment via rotary switch
- ▶ Available with UL approval
- ▶ Versatile relays
- ▶ Preventive maintenance through early fault detection
- ▶ Reliable protection of motors and system components
- ▶ Precise monitoring of different measured values
- ▶ Use without additional auxiliary voltage (exception RL 9853)
- ▶ Large measuring range
- ▶ Extensive range of measuring relays from a single source

Our experience. Your safety.

Measuring and monitoring relays

Technical features (for type RL 9877)

- ▶ According to IEC/EN 60 255-1
- ▶ For monitoring 3 and 1 phases
- ▶ Alternating voltages with 50 / 60 Hz
- ▶ Detection of
 - Overvoltage
 - Undervoltage
 - Voltage range excess
 - Phase failure
 - Phase asymmetry
 - Missing neutral conductor or neutral conductor break
 - Direction of rotation in 3-phase networks
- ▶ With or without neutral connection
- ▶ Output: 1 changeover contact
- ▶ Closed-circuit principle
- ▶ Without separate auxiliary voltage
- ▶ Adjustable hysteresis for switching back to good state
- ▶ Adjustable switching delay
- ▶ Fast fault detection
- ▶ Width 35 mm



RL series
35 mm width



RN series
52.5 mm width

Applications

- ▶ Machinery and plant construction
- ▶ Engineering and planning offices
- ▶ Control and switchgear construction
- ▶ Industrial service and repair
- ▶ Building and electrical installation technology



Type



3 AC phase monitor
RL 9877



Fuse monitor
RL 9075



AC voltage relay
RL 9854



DC voltage relay
RL 9836



3 AC phase monitors
RN 9877



Fuse monitor
RN 9075



AC/DC current relay
RL 9853



Further information

RL 9877

Start

www.dold.com

DOLD

E. Dold & Söhne GmbH & Co. KG
Bregstraße 18 • D-78120 Furtwangen
T +49 7723 654-0 • F +49 7723 654-356
dold-relays@dold.com • www.dold.com



MINISTART

Smart motorstarter UG 9410 - With Modbus RTU - IE3 ready

DOLD

The **smart motorstarter UG 9410** of the **MINISTART** series from DOLD combines up to 7 functions in a compact enclosure with a width of only 22.5 mm. The motorstarter ensures reliable soft starting, soft stopping, reversing and protection of 3-phase asynchronous motors. Whether for retrofitting or original equipment, the device can be used in a space-saving manner and, in addition to phase sequence monitoring, also offers an integrated motor protection function and phase failure detection.

Commissioning, parameterisation and control are carried out quickly and easily via the Modbus RTU interface. The fieldbus connection saves wiring and offers extensive diagnostic options that improve reliability and increase system availability.

The UG 9410 guarantees a low-wear and gentle start for your machines and plants and is suitable for demanding drive tasks. The areas of application include in particular reversing drives such as door and gate controls, conveyor systems as well as bridge and actuator drives.

Advantages and customer benefits

- ▶ Up to 7 functions in one device: anticlockwise / clockwise rotation, soft start, soft stop, phase failure monitoring, motor protection and phase sequence monitoring
- ▶ Simple commissioning, control and parameterisation via Modbus RTU
- ▶ Considerable space saving in the switch cabinet due to only 22.5 mm width
- ▶ Extensive diagnostic options through fieldbus connection
- ▶ Suitable for IE1, IE2 and IE3 motors
- ▶ High device availability due to
 - Semiconductor temperature monitoring
 - High dielectric strength of semiconductors up to 1500 V
 - Load free relay reversing function and device overload protection

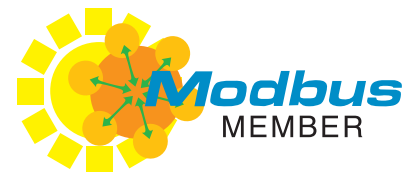

Our experience. Your safety.

Smart motorstarter UG 9410 - Modbus RTU

Technical features

- ▶ According to IEC/EN 60 947-4-2
- ▶ Modbus RTU interface
- ▶ For turning 3-phase motors from 0.18 kW ... 2.2 kW at 400 V
- ▶ 2-phase soft start, soft stop
- ▶ 3 rotary switches for setting the Modbus address and baud rate
- ▶ 5 LEDs as status display
- ▶ Current free reversing with relays, soft start, soft stop with thyristors
- ▶ Galvanic isolation of control and main circuit
- ▶ Width 22,5 mm



3-phase smart motorstarter
UG 9410

Order information

Standard type: UG 9410PM 3 AC 200 ... 480 V 50/60 Hz 5.0 A
Item number: 0067521

Standard type: UG 9411PM AC 230 V 50/60 Hz 7.0 A
Item number: 0067523



1-phase smart motorstarter
UG 9411

Fields of application

- ▶ Reversing drives for door and gate controls
- ▶ Conveyor systems with blocking monitoring
- ▶ Actuators in process engineering
- ▶ Packaging machinery
- ▶ Washing plants and car washes

Functions



Reversing (anticlockwise / clockwise)

Clockwise and anticlockwise rotation can be selected via Modbus RTU. The reversal of the direction of rotation is wear-free due to semiconductor elements and motor-friendly due to the integrated soft start function.



Soft start / soft stop

The drive can start and stop jerk-free and the drive elements are not damaged, i.e. maximum protection for mains, motor and machine.



Phase failure detection

In order not to load the motor with asymmetrical currents, it is checked at motor start whether phases L1, L2, L3 are present.



Phase sequence monitoring

The phase sequence monitoring checks the direction of rotation of the phase voltage after switching on and reports an error with anticlockwise rotating field.



Motor protection

Comfortable protection by the electronic motor protection relay with automatic and remote reset function.



IE3 ready

Gentle operation of three-phase motors in efficiency classes IE1, IE2 and IE3.

Further information

UG 9410

Start

www.dold.com

DOLD

E. Dold & Söhne GmbH & Co. KG
Bregstraße 18 • D-78120 Furtwangen
T +49 7723 654-0 • F +49 7723 654-356
dold-relays@dold.com • www.dold.com



MINISTART

Smart motorstarter UG 9256/804 - Automatic correction of the direction of rotation

DOLD 

The **smart motorstarter UG 9256/804** of the **MINISTART** series is designed for reliable starting of asynchronous motors and ensures that a clockwise rotating field is always applied to the motor when connected to the mains and that the motor runs correctly right away. The device automatically corrects the rotating field if the mains connection is incorrect, thereby preventing the motor from running backwards and being damaged.

The only 22.5 mm wide phase inverter has UL approval and offers automatic phase correction, an integrated motor protection function and phase failure detection to protect the motor - optionally also with galvanic mains isolation via relay with forcibly guided contacts.

The UG 9256/804 is suitable for applications in which devices are connected to the mains at different locations, in particular for mobile machines such as pumps, blowers, grinding machines and compressors as well as for use by the fire brigade or the Federal Agency for Technical Relief. Whether retrofitting or original equipment, the phase inverter can be used in a space-saving manner and always ensures the correct direction of rotation. Troubleshooting or rewiring is therefore no longer necessary.

Advantages and customer benefits

- ▶ Up to five functions in one UL-approved device:
Ensures clockwise rotating field, phase failure detection, motor protection, soft start and optional galvanic mains isolation through forcibly guided contacts
- ▶ Automatic correction of the rotary field in case of incorrect connection
- ▶ No troubleshooting in the wiring
- ▶ No phase inverter plug required
- ▶ Damage prevention through correct direction of rotation
- ▶ Considerable space saving due to only 22.5 mm width
- ▶ Simple device adjustment via rotary switch
- ▶ Suitable for IE1, IE2 and IE3 motors
- ▶ Increased service life due to hybrid design
- ▶ Integrated protection against overtemperature of the motor

Our experience. Your safety.

Smart motorstarter UG 9256/804

Technical features

- ▶ According to UL 60947-4-2
- ▶ For turning the rotating field
- ▶ For 3-phase motors with rated motor currents of I_e 1.5 A ... 9,0 A
- ▶ Robust power semiconductors up to 1500 V
- ▶ 1 potentiometer for setting rated motor current
- ▶ 3 LEDs for status indication
- ▶ Current free turning with relays, switching with thyristors
- ▶ Galvanically isolated 24 V input for clockwise rotation
- ▶ Reset button on front panel
- ▶ Connection option for external reset button
- ▶ Relay alarm output for operational readiness
- ▶ Galvanic isolation of control and main circuit
- ▶ Galvanic isolation of motor connection terminal and mains voltage in idle or fault state (UG 9256/807)
- ▶ Width 22,5 mm



Smart motorstarter
UG 9256/804



Order information

Standard type:
UG 9256.11/804/61 3 AC 200 ... 480 V 9,0 A
Item number: 0066450

Standard type with mains cut-off relay:
UG 9256.11/807/61 3 AC 200 ... 480 V 9,0 A
Item number: 0067133

Fields of application

- ▶ Mobile pumps, grinding machines, compressors etc.
- ▶ Blowers, fans and vacuum cleaners
- ▶ Conveying equipment and actuators with preferred direction of rotation

Functions



Automatic rotating field correction (clockwise rotation)

The device ensures that there is always a clockwise rotating field on the motor irrespective of the input rotating field and that the motor runs correctly at the first attempt. The reversal of the direction of rotation is wear-free.



Phase failure detection

In order not to load the motor with asymmetrical currents, it is checked at motor start whether phases L1, L2, L3 are present.



Motor protection

Electronic replica of the bimetal function for motor protection. Convenient setting on the front panel with rotary switch. Automatic and remote reset possible.



Soft start

To reduce the motor starting current and protect the drive, the motor starter is equipped with a fixed soft start function.



Galvanic mains isolation (optional with /807)

In the idle or fault state of the motor, the motor connection terminals are disconnected from the mains voltage via a forcibly guided relay (contact spacing at least 0.5 mm).

Further information

UG 9256/804

Start

www.dold.com

DOLD

E. Dold & Söhne GmbH & Co. KG
Bregstraße 18 • D-78120 Furtwangen
T +49 7723 654-0 • F +49 7723 654-356
dold-relays@dold.com • www.dold.com



MINISTART

Smart motorstarter UG 9256 - With motor protection function

DOLD 

Sophisticated drive tasks require powerful and flexible device solutions. The **smart motorstarter UG 9256** of the **MINISTART** series from DOLD with load monitoring for motors up to 4 kW combines up to six functions in a space saving compact enclosure with only 22,5 mm width. Besides the reversal function our smart motorstarter also offers a soft start / soft stop function, a current monitoring as well as a motor protection function and a galvanic separation by an all pole disconnection when motor is switched off.

Due to the integrated motor protection function separate motor protection switches are not necessary. A power protection switch takes over the wire- and short circuit protection of the whole system. An internal relay provides galvanic isolation of the power outputs. While the semiconductor control provides a soft motor start, the direction reversal takes place through relay switching. The hybrid relay thus combines the advantages of rugged relay technology with non-wearing semiconductor technology. The user benefits from a significantly longer device service life and improved reliability. The integrated current monitoring protection enhances the system availability even further.

Your advantages

- ▶ Up to six functions in one device:
reversing clockwise / anticlockwise, soft start, current monitoring or motor protection, galvanic separation, soft stop
- ▶ Space saving in switching cabinet due to a width of only 22,5 mm
- ▶ Simple and time-saving commissioning as well as user-friendly operation, optionally with motor protection
- ▶ Robust power semiconductors up to 1500 V
- ▶ Increased system availability through over current protection
- ▶ Higher life time by hybrid building
- ▶ Energy saving by fast over current protection

Our experience. Your safety.

Smart motorstarter UG 9256

Technical features

- ▶ For the reversal of 3-phase motors up to 3 AC 480 V / 9 A, corresponds to 4 kW at 400 V
- ▶ Currentless reversal with relay, softstart with thyristors
- ▶ 2-phase softstart
- ▶ Integrated short-circuiting contacts
- ▶ 3 potentiometers to set the starting torque, softstart time and overcurrent limit
- ▶ 4 LEDs as status indicator
- ▶ Reset button internal and external

Device measurements in mm (W x H x D)

22.5 x 105 x 120.3

Ordering information

Standard type:
UG 9256.11/010/61 3 AC 200...480 V 9,0 A 1...10 s
Item number 0064445

Applications

- ▶ Reversing drives for door and gate controls, bridge drives and lifting gear with current monitoring
 - ▶ Conveyor equipment with current monitoring
 - ▶ Positioning drives in process engineering (chemistry and petrochemicals) with current monitoring
 - ▶ Point drives
 - ▶ Helms
- ... and for all applications with sophisticated motor control processes.

Functions



"6 in 1"

Reversals

Right-handed rotation and left-handed rotation can be selected via two control inputs. The rotational direction reversal takes place without wear through semiconductor elements and preservation of the motor through integrated softstart function.



Softstart / soft running-down

The drive can start and run down without jerking and the drive -elements are not damaged, i.e. maximum preservation of mains, motor and machine. Starting time and running down torque can be adjusted via potentiometers.



Current monitoring (optional)

To protect against stalled motor protection the motor current is monitored in T3. The switching threshold can be adjusted via potentiometer. This provides permanent protection of motor and machine against overload.



Galvanic isolation

In the static or fault state of the motor the motor terminals are separated from the mains Voltage via a 3-pole guided relay.



Motor protection (optional)

Electronical analogue of the bimetal function for the motor protection. Comfortable adjustment on the front of the device via a potentiometer automatic and distant reset is possible.

Further information

UG 9256

Start

www.dold.com



Smart motorstarter
UG 9256



Advantages of semiconductor technology

- ▶ Non-wearing switching
- ▶ Long service life
- ▶ High switching frequencies
- ▶ Small footprint
- ▶ Stable and short response times
- ▶ Suitable for rugged environments

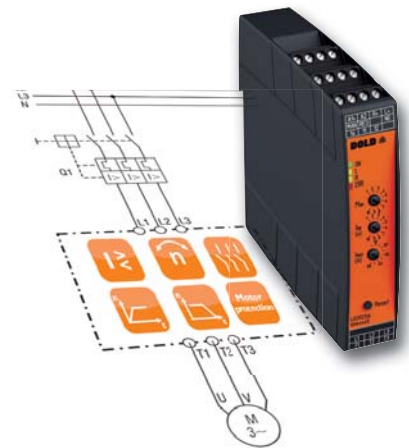

DOLD

E. Dold & Söhne GmbH & Co. KG
Bregstraße 18 • D-78120 Furtwangen
T +49 7723 654-0 • F +49 7723 654-356
dold-relays@dold.com • www.dold.com



MINISTART

Softstarter / Softstop UG 9019 Smooth control of motors



With the **softstarter UG 9019** from the **MINISTART** series, DOLD offers a reliable softstart and softstop device with a width of only 22.5 mm. The slim, two phase controlled softstarter for the power range of up to 4 kW combines perfect starting and stopping characteristics with intelligent monitoring functions. In doing so, it allows both smooth control and simplified drive monitoring in a wide variety of application fields. Optional function possibilities offer additional advantages even for challenging applications.

With the UG 9019 DOLD has developed an intelligent version that makes assembly easy even in existing units by simply clipping on to the DIN rail. The device is also suitable for retrofitting due to its narrow construction type. Starting and deceleration time can be selected conveniently and continuously variable via rotary switches as a standard feature. The starting voltage can be individually adjusted and a relay output shows that the device is ready for operation.

The UG 9019 is optimally equipped with regard to monitoring and safety. Phase failure, phase sequence or overtemperature are recognised instantly and displayed by luminous diodes and indicator contacts. Versatile functionality, flexible adjusting possibilities and a compact construction type: Soft starting has never been this simple.

Advantages and customer benefit

- ▶ Soft starting and deceleration
- ▶ Continuously variable starting and minimised starting current
- ▶ Simple device setting via rotary switches
- ▶ Reduction of current peaks
- ▶ Wear free switching
- ▶ Increase of service life of motors
- ▶ Suitable for IE1, IE2, and IE3 motors
- ▶ Decrease of mechanical stress in the drive
- ▶ Considerable saving of space compared with conventional starters

Our experience. Your safety.

Softstarter / Softstop UG 9019

Technical features

- ▶ Soft starting and softstop function
- ▶ In accordance with IEC 60947-4-2
- ▶ 2-phase softstart and softstop of 3-phase motors up to 4 kW at 400 V
- ▶ 4 potentiometers to set starting torque, deceleration torque, soft start/soft stop time
- ▶ 3 LEDs as indicators
- ▶ Reset button on the front
- ▶ Separate adjusting possibility of starting and stopping time or starting voltage
- ▶ Connection possibility for external reset button
- ▶ Relay indicator output to signal ready for operation
- ▶ Galvanic separation between control and power circuit
- ▶ DIN rail mounting
- ▶ Width 22.5 mm



Softstarter
UG 9019



Order information

Standard type:
UG 9019.11/110/61 3 AC 200 ... 480 V 9,0 A 1 ... 10 s
Item number: 0067032

Fields of application

- ▶ Machines with gear, belt or chain drives
- ▶ Conveyor belts
- ▶ Fans, pumps and compressors
- ▶ Washing installations and car-wash plants
- ▶ Woodworking machines and centrifuges
- ▶ Packaging machines and transformers
- ▶ Door and gate drives

Application example

The softstarter UG 9019 is suitable for nearly every application up to 4 kW motor power at 400 V, which require reduced torques when starting and stopping. For instance for the drive of conveyor belts, compressors, grinding machines and many more. The device guarantees a soft start, so that drive elements are not damaged by abrupt start-up after starting. The soft stopping function should extend the natural deceleration of the drive, also in order to avoid jerky stopping.

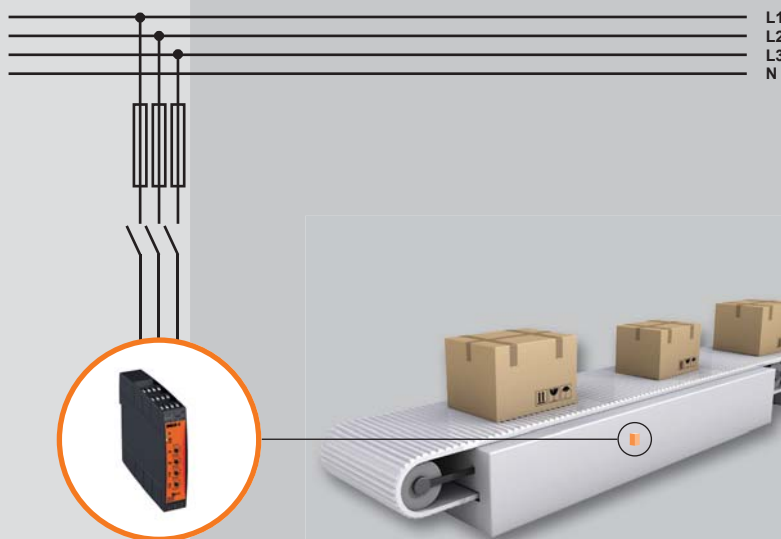

Further information

UG 9019

Start

www.dold.com

DOLD



E. Dold & Söhne GmbH & Co. KG
Bregstraße 18 • D-78120 Furtwangen
T +49 7723 654-0 • F +49 7723 654-356
dold-relays@dold.com • www.dold.com



MINISTART

Softstarter UH 9018

With the **softstarter UH 9018** from the **MINISTART** series, DOLD offers a reliable softstarter available in four performance levels. The compact, two-phase controlled softstarter for an output range from 1.5 to 7.5 kW combines optimal start-up and run-down characteristics with intelligent monitoring functions. Optional functions offer additional advantages, even for challenging applications. These allow the soft starter to offer both gentle control and simplified drive monitoring in a wide variety of applications.

With the UH 9018, DOLD has developed an inexpensive option that can even be a substitute for a star-delta starter. Its slim construction and the ability to snap the device onto 35 mm standard rails makes it easy to install, even in existing systems. The start-up and run-down time can be continuously controlled using potentiometers as a standard feature. The starting voltage can be individually adjusted. The boost function also allows operators to start drives with high holding torque at a standstill.

The UH 9018 series is excellently equipped with regard to monitoring and security. Low voltage, phase / ignition failures or high temperatures are detected instantly and displayed using LEDs and signaling contacts. Diverse functions, flexible setting options, and a compact construction: UH 9018 makes it possible. Soft starting has never been so simple.

Advantages and customer benefit

- ▶ To limit start-up current and for stable network conditions
- ▶ Jolt-free start and minimized start-up current
- ▶ Increases the life span of motors and mechanical drive components
- ▶ Protects the drive unit
- ▶ Integrated bypass conductor
- ▶ Simple operation
- ▶ Comprehensive diagnosis through LED flash code

DOLD 

Our experience. Your safety.

Softstarter UH 9018

Technical features

- ▶ Soft start and soft stop function
- ▶ For motor output of 1.5 kW to 7.5 kW
- ▶ 2-phase motor control
- ▶ Option to set start-up and run-down time or starting voltage separately
- ▶ Kickstart (boost) function
- ▶ Top hat rail mounting
- ▶ Protection class IP20
- ▶ Compact construction, 45 mm construction width

Order information

Standard type: UH 9018 3 AC 400 V 50/60 Hz 1.5 kW
Item number: 0066471

Standard type: UH 9018 /110 3 AC 400 V 50/60 Hz 7,5 kW
Item number: 0068626

Fields of application

- ▶ Machines with gear, belt, and chain drives
- ▶ Conveyor belts, fans, pumps, compressors
- ▶ Woodworking machines, centrifuges
- ▶ Packaging machines, transformers

Application

The softstarter UH 9018 is suitable for challenging applications requiring reduced torque during start-up and run-down. The device ensures that the drive can start up smoothly. This precludes the drive elements from being damaged, because no abrupt starting torque occurs when the device is switched on directly. After a successful start-up, the power semiconductor is bridged using internal relay contacts in order to minimize loss within the device. The soft start function is designed to extend the natural run-down time of the drive, also preventing an abrupt stop.



Softstarter
UH 9018

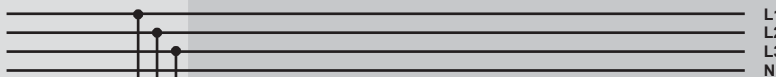

Soft
Start

Soft
Stop

Boost

I >

Further information

UH 9018

Start

www.dold.com

DOLD

E. Dold & Söhne GmbH & Co. KG
Bregstraße 18 • D-78120 Furtwangen
T +49 7723 654-0 • F +49 7723 654-356
dold-relays@dold.com • www.dold.com



MINISTART

Softstarter PF 9015 - IE3 ready

DOLD

The new **softstarter PF 9015** of the **MINISTART** family from DOLD is a robust electronic control unit for the soft start of motors up to 40 A with integrated monitoring functions and a width of only 67.5 mm. To operate the motor reliably, the PF 9015 offers soft start, motor protection, voltage and phase sequence monitoring in just one device.

The compact 3-phase controlled softstarter enables a smooth and gentle start (start-up time up to 20 s) due to a reduced starting current. The current peaks and torque shocks that interfere with switching are reduced. This increases the service life of the motors and mechanical drive components.

Monitoring the rotating field (clockwise) prevents motors from starting up in the wrong direction of rotation. The integrated undervoltage and overvoltage monitoring as well as the motor protection function according to Class 10 protect the motor against overload. The most important functions of the device include blockage protection in bypass mode, detection of missing load and integrated temperature monitoring of the power semiconductors. With the softstarter PF 9015, the user has a smart, user-friendly softstarter with extensive monitoring and protection functions.

Advantages and customer benefits

- ▶ Space-saving switch cabinet installation with a width of only 67.5 mm
- ▶ Improved starting current reduction
- ▶ Less self-heating
- ▶ Only 1 device for soft start, motor protection, voltage and phase sequence monitoring
- ▶ Gentle starting and reduced starting current
- ▶ Increases the service life of the drives
- ▶ No mains filter required due to low interference radiation
- ▶ Soft start / soft stop time 1 ... 20 s
- ▶ Low installation costs

Our experience. Your safety.

Softstarter PF 9015

Technical features

- ▶ According to IEC/EN 60 947-4-2
- ▶ Suitable for IE3 motors
- ▶ 3-phase controlled with integrated bypass relay
- ▶ Phase sequence monitoring
- ▶ Blocking protection in bypass mode
- ▶ Integrated motor protection according to class 10 of IEC/EN 60947-4-2
- ▶ Starting current limitation
- ▶ Thyristor monitoring
- ▶ Detection of missing load
- ▶ Automatic frequency recognition of the load voltage
- ▶ Temperature monitoring of power semiconductors
- ▶ Kickstart function
- ▶ Width 67.5 mm



Softstarter
PF 9015

Order information

Standard type:
PF 9015.11 3 AC 200 ... 480 V 50 Hz UH 230 V 20 A
Item number: 0068478

Further variants (up to 40 A) on request

Fields of application

- ▶ Conveyor belts
- ▶ Pumps
- ▶ Air conditioners, compressors

Applications

The softstarter PF 9015 is suitable for applications requiring reduced starting torques. For example, for driving conveyor belts, compressors, grinding machines and many more. The device ensures a smooth, gentle start-up so that drive elements are not damaged. After start-up, the power semiconductors are bypassed by relays to minimize power dissipation in the device.

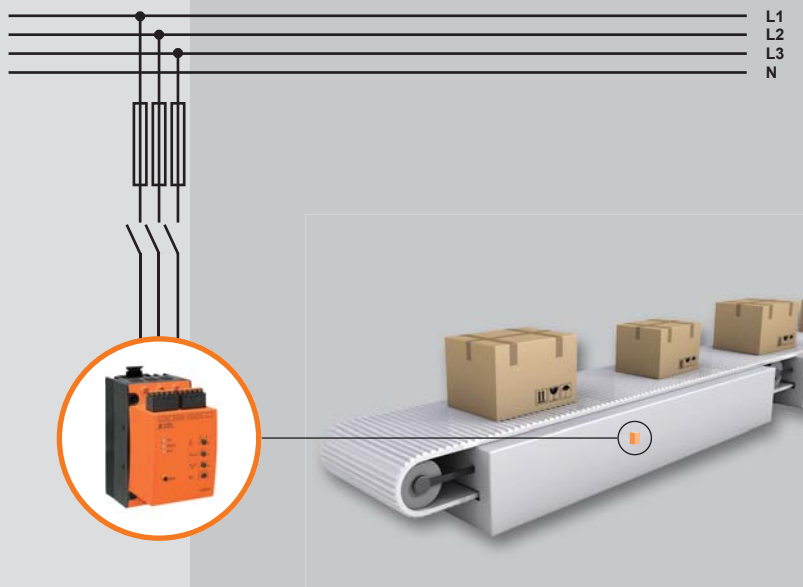

Soft
Start



Motor
protection

IE3
ready

Further information

PF 9015

Start

www.dold.com

DOLD

E. Dold & Söhne GmbH & Co. KG
Bregstraße 18 • D-78120 Furtwangen
T +49 7723 654-0 • F +49 7723 654-356
dold-relays@dold.com • www.dold.com



POWERSWITCH

DOLD 

Solid-state relay / contactor PI 9260 - Reliable and noiseless switching

With the new **solid-state relay PI 9260**, the **POWERSWITCH** family from DOLD has been supplemented by a further attractive electronic switching device. The solid-state contactor has been specially developed for switching resistive and inductive three-phase loads and therefore serves as an electronic contactor replacement. Both 2- and 3-phase controlled versions are available. The DCB technology (Direct-Copper-Bonding) ensures optimum heat transfer, which allows switching of large load currents and at the same time ensures high reliability and robustness.

The PI 9260 is characterized by a wear-free and noiseless switching of currents up to 60 A. The long service life of the PI 9260 ensures high reliability and robustness. The long service life saves you costly and time-consuming replacement of the device. The device can be mounted on existing cooling surfaces. Optionally, the solid-state contactor PI 9260 is also available with a correspondingly pre-dimensioned heat sink, which enables quick and easy commissioning.

Due to the short reaction time, high peak current compatibility and high EMC resistance, this shock- and vibration-resistant solid-state relay is predestined for many applications. These include, for example, heating and cooling systems, process controls, plastic injection machines, motor valves and many other applications.

Advantages and customer benefits

- ▶ Immediately ready for use - thanks to optimally adapted heat sinks
- ▶ Long service life ensures high system availability
- ▶ Low interference emission, immune to interference radiation
- ▶ Noiseless and wear-free switching - even at high switching frequencies
- ▶ Shock and vibration resistant
- ▶ Easy integration into existing automation systems
- ▶ Wide voltage range for control and load voltage



Our experience. Your safety.

Solid-state relay / contactor PI 9260

Technical features

- ▶ 3-phase AC solid-state relay / contactor
- ▶ According to IEC/EN 60947-4-3
- ▶ Zero voltage switching or instantaneous switching
- ▶ 2 antiparallel thyristors at each pole
- ▶ DCB (Direct-Copper-Bonding) technology for optimum heat transfer properties
- ▶ Load current up to 60 A
- ▶ Peak reverse voltage up to AC 1600 Vp
- ▶ Control voltages up to AC 230 V
- ▶ Wide AC and DC input control range
- ▶ LED status indicators
- ▶ Optionally with heat sink, snaps onto top-hat rail
- ▶ Box terminals with self-lifting wire protection for control and load circuit
- ▶ Protection class IP20
- ▶ Width 67.5 mm

Order information

Standard type: PI 9260.92/000/06 (incl. heat sink)
 AC 48 ... 480 V 2 x 30 A DC 10 ... 32 V
 Item Number: 0067462

Fields of application

- ▶ Rubber and plastics industry
- ▶ Food and beverage industry
- ▶ Heating, cooling and air-conditioning technology
- ▶ Packaging industry
- ▶ Semiconductor industry

Application example

In extrusion machines it is important to have constant process temperatures. This is the only way to ensure that the extruded parts have a constant quality. This is why solid-state relays are used to switch the heating elements. In contrast to mechanical contactors, these allow fast switching of the heating elements. Thus the temperature is regulated very precisely. Solid-state relays can withstand this operation over the entire service life of the machine because they are not subject to any wear.

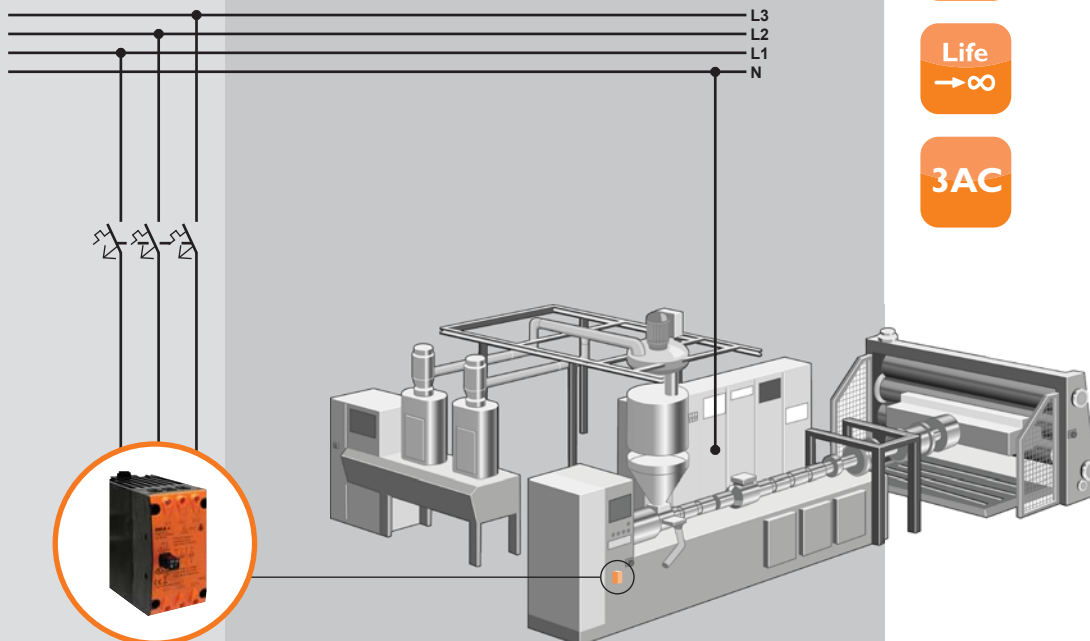

Further information

PI 9260

Start

www.dold.com

PH 9270

Do you need a **solid-state relay** with **additional load monitoring**?



Solid-state contactor
 PI 9260



0 dB

f >

°C°

Life
 → ∞

3AC

DOLD

E. Dold & Söhne GmbH & Co. KG
 Bregstraße 18 • D-78120 Furtwangen
 T +49 7723 654-0 • F +49 7723 654-356
 dold-relays@dold.com • www.dold.com



POWERSWITCH

Solid-state relay / contactor PK 9260 - More functions, more options

DOLD

In order to improve the competitiveness of industrial systems, more and more companies are focusing on increasing their productivity. The result is a steady increase in switching frequencies. Conventional switching devices often have a hard time keeping up. The **solid-state relay PK 9260** from the **DOLD POWERSWITCH** series is the ideal solution. Once it is installed, the device remains active almost endlessly. Regularly exchanging devices – which costs both time and money – can be eliminated in the future. The PK 9260 stands out for its wear-free and low-noise switching operation and it is able to safely and reliably stand up to repeated loads and high temperatures. The solid-state relay PK 9260 offers quick and easy commissioning through its ready-to-use construction.

The PK 9260 has two thyristors connected in reverse parallel, allowing it to function as a zero voltage switch for resistive loads. The DCB technology (direct copper bonding process) provides very good thermal transfer, making very high load currents possible. In addition, the device can be installed directly on existing cooling surfaces. It is available as a solid-state contactor with an appropriately dimensioned heat sink and can easily be snapped onto a top hat rail. A LED display signals the status of the control input.

Your advantages

- ▶ Ready to use immediately – with an optimally designed heat sink
- ▶ Almost unlimited life span for high system availability
- ▶ Noiseless and wear-free switching – even at high switching frequencies
- ▶ Easy integration into existing automation systems
- ▶ Compact size of just 22.5 mm
- ▶ Flexible wiring and easy commissioning
- ▶ Can also be used in extreme environmental conditions (dust-proof, vibration and shock resistant)



Our experience. Your safety.

Solid-state relay / contactor PK 9260

Technical features

- ▶ AC solid-state relay / contactor
- ▶ In accordance with IEC/EN 62314, IEC/EN 60947-4-2 and -4-3
- ▶ 2 thyristors in reverse parallel
- ▶ DCB technology (direct copper bonding process) for very good thermal transfer properties
- ▶ Load current up to 88 A, AC-51
- ▶ Peak voltage up to AC 1600 V
- ▶ Insulation voltage 4000 V
- ▶ Control voltage up to AC 230 V
- ▶ LED status display
- ▶ Available with heat sink, snaps onto top hat rail
- ▶ Connect with M4 flat terminal or M5 screw terminal for cable lugs up to 25 mm²
- ▶ Zero voltage switch for resistive loads
- ▶ Width 22.5 mm



Solid-state contactor
PK 9260

Order information

Standard type: PK 9260.91
AC 48 ... 460 V 50 A DC 4 ... 32 V
Item number: 0064885

PK 9260.91/000/04 (+ heat sink)
AC 48 ... 460 V 20 A DC 4 ... 32 V
Item number: 0064886

Areas of application

- ▶ Rubber and plastics industry
- ▶ Food and drink industry
- ▶ Heating cooling and air conditioning technology
- ▶ Packaging industry
- ▶ Semiconductor industry

Examples of application

Plastic injection molding machines must be divided into multiple heating zones for efficient control. This requires a large number of solid-state switching devices in the system. Due to the multiple devices and narrow space available in the machine, a compact design is an important basic feature. Narrow PK 9260 solid state relays can truly shine in such applications. The devices can easily be installed on an accumulator heat sink.

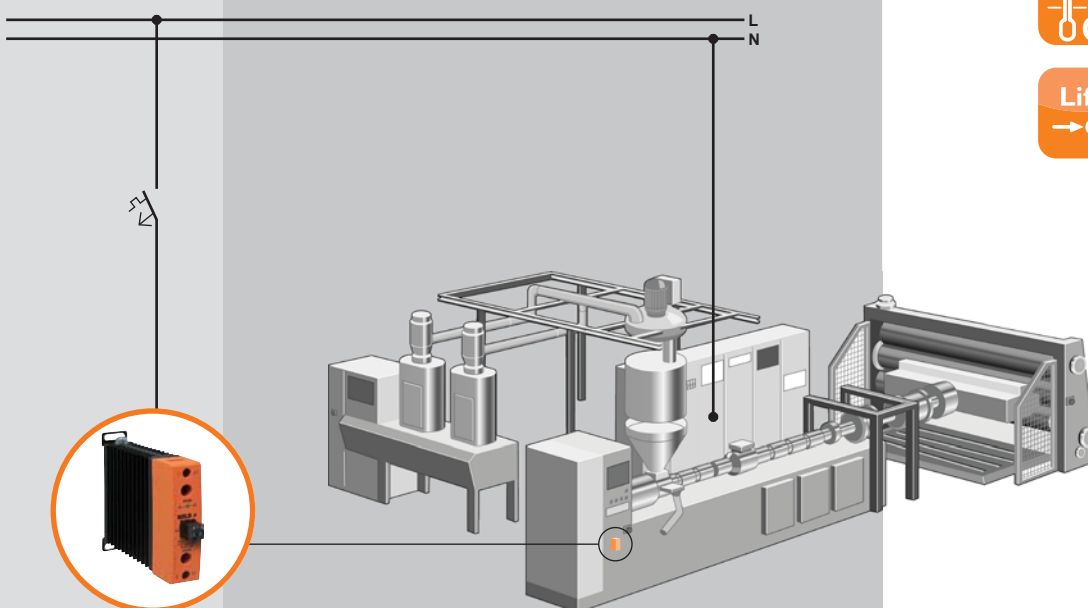

Further information

PK 9260

Start

www.dold.com

Do you need a **solid-state relay with additional load monitoring?**

PH 9270

DOLD

E. Dold & Söhne GmbH & Co. KG
Bregstraße 18 • D-78120 Furtwangen
T +49 7723 654-0 • F +49 7723 654-356
dold-relays@dold.com • www.dold.com



POWERSWITCH

Hybrid relay IK 3070/200 - Perfectly combined

DOLD 

Hybrid relays combine the advantages of robust relay technology with wear-resistant semiconductor technology in a perfect way. Classic electromechanical relays offer a significant advantage over solid-state relays. While solid-state relays generate heat permanently due to the forward voltage, which must be dissipated by heat sinks at higher load currents, the current-carrying relay contact has a very low contact resistance and thus generates hardly any heat loss.

Solid-state relays are insensitive to shock and vibration. Their strengths lie above all in the switch-on and switch-off processes. No bouncing, no electric arcs, no mechanical wear - and thus an almost unlimited electrical service life.

The **hybrid relay IK 3070/200** from DOLD perfectly combines the advantages of both worlds. When switched on, the solid-state first switches in the zero crossing of the alternating voltage. A few milliseconds later, the relay contact takes over the continuous current and ensures low power dissipation. When the relay is switched off, the current is first transferred from the relay to the solid-state, which then switches off at zero current. In this way, surge voltages and currents in the load circuit are minimized.

Due to the combination of the different switching technologies, the IK 3070/200 is particularly suitable for applications that require a high switching capacity and a long service life at the same time. It shows its strength in systems in which a standstill leads to high costs. Applications can be found in automation technology and the process industry as well as in offshore wind turbines.

Advantages and customer benefits

- ▶ Long service life thanks to hybrid technology
- ▶ Space-saving with an overall width of only 17.5 mm
- ▶ For loads with very high inrush currents

Our experience. Your safety.

Hybrid relay IK 3070/200

Technical features

- ▶ According to IEC/EN 60 947-4-3
- ▶ Rated operational current 20 A
- ▶ Long electrical life of $>10^6$ switching operations with AC 15, 10 A inductive
- ▶ Low-noise switching
- ▶ For switching resistive, inductive and capacitive loads
- ▶ Zero voltage switching
- ▶ 1 NO contact
- ▶ 17.5 mm width



Hybrid relay
IK 3070/200

Order information

Standard type:
IK 3070.01/200 AC 220 ... 240 V 50 / 60 Hz
Item number: 0054593

Fields of application

- ▶ Automation and process technology
- ▶ Heating, air-conditioning, ventilation and lighting technology
- ▶ Energy saving and LED lamps
- ▶ Offshore wind turbines

Structure

Switch on:

Triac precedes contact. It switches on at zero voltage crossing and takes over the high inrush currents, e.g. for incandescent lamps (PTC thermistors), electronic ballasts for fluorescent lamps or devices with a high capacitive load.

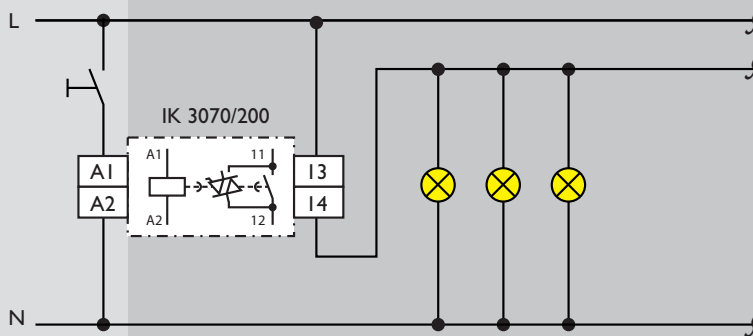

Switch off:

Triac follows the contact. It switches off at zero crossing of the current and thus prevents a strong spark formation and thus an early failure of the contact with inductive loads.

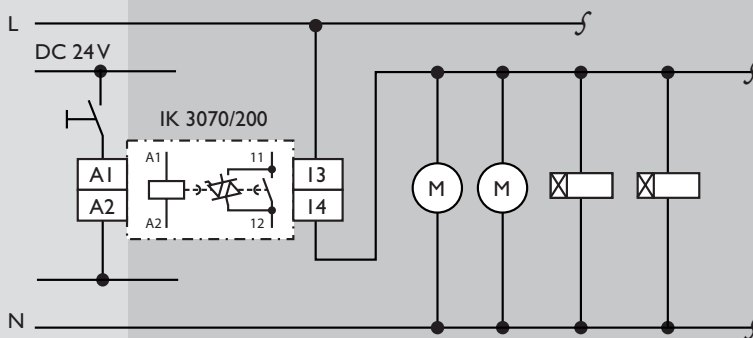

Further information

IK 3070/200

Start

www.dold.com

DOLD

E. Dold & Söhne GmbH & Co. KG
Bregstraße 18 • D-78120 Furtwangen
T +49 7723 654-0 • F +49 7723 654-356
dold-relays@dold.com • www.dold.com

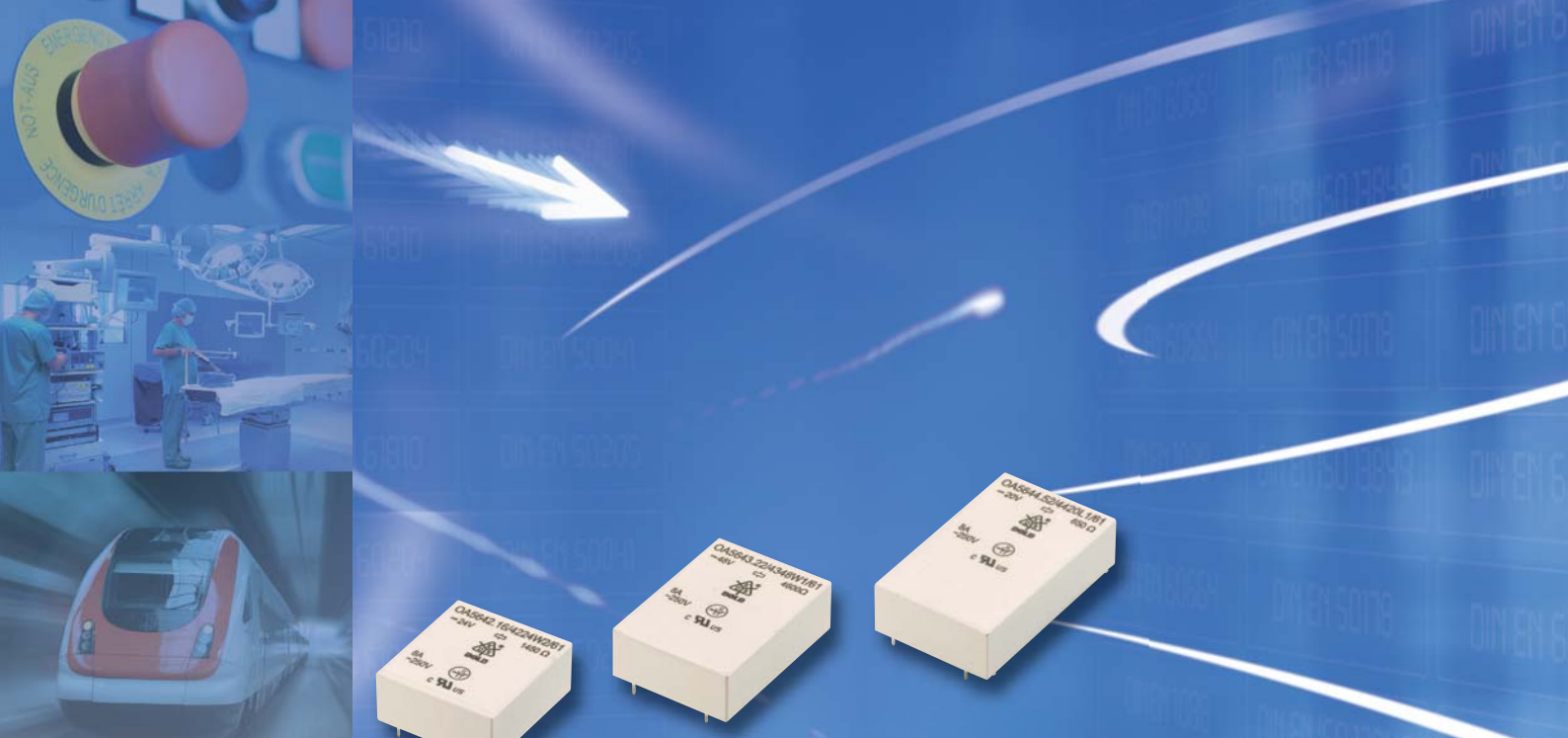

Safety relays OA 5642/43/44

DOLD 

With forcibly guided contacts -
only 10.3 mm height

In many safety-related applications where relays with forcibly guided contacts (in accordance with DIN EN 61810-3) are used special attention is paid to a compact design, apart from the high switching reliability.

With the new **safety relays OA 5642, OA 5643 and OA 5644** DOLD provides an extremely flat relay range setting new standards. Only **10.3 mm in height**, these 2-, 3- and 4-pole relays are among the flattest safety relays on the market. They are ideal for the realisation of compact safety switching devices (only 15 mm in width) and for applications where little space in height is available. Besides compactness, the design of the relays also allows an arrangement of SMD components between board and relay.

For applications where the power consumption is critical, energy saving was particularly taken into account by nominal power values of only 0.4 W, 0.5 W and 0.65 W and a lowering of the holding power to about a third of the pickup power. The relay, which is wash-tight (RT III) and temperature-stable up to 85° C in its standard version, can be especially well processed in leadfree solder processes.

Advantages and customer benefit

- ▶ Smallest height of 10.3 mm while requiring a minimum of area
- ▶ Low nominal and holding power
- ▶ Protective separation between all circuits;
for applications with pollution severity 2; and design insulation voltage of 250 V
- ▶ Relay range with consistent connection pinning
- ▶ Contact combinations for your specific application (on request)
- ▶ Wide temperature range
- ▶ High resistance to shock and vibration
- ▶ Wash-tight
- ▶ Low weight

Our experience. Your safety.

Safety relays OA 5642, OA 5643, OA 5644

Technical features	OA 5642	OA 5643	OA 5644
Height	▶ 10,3 mm	10,3 mm	10,3 mm
Area	▶ 26,6 x 25 mm	34,2 x 25 mm	41,7 x 25 mm
Nominal consumption	▶ 0,4 W	0,5 W	0,65 W
Breaking current	▶ 10 mA to 8 A	10 mA to 8 A	10 mA to 8 A
Contacts	▶ 2 1NO/1NC	3 2NO/1NC	4 2NO/2NC; 3NO/1NC
Contact material	▶ AgSnO ₂ , AgNi, AgNi + hard gold plating		
Temperature range	▶ - 40 ... + 85° C		
Approvals	▶ cRUus, TÜV		



OA 5642



OA 5643



OA 5644

Notes on ordering

For all relay models, the contact materials AgSnO₂, AgNi and AgNi + 5 µm hard gold plating are possible. In combination with the proven mini-crown, currents from 10 mA up to 8 A can be reliably switched. As almost all coil voltages between 6 V and 110 V are available, the customer can get a safety relay tailored to his specific application.

Please ask us.

Applications

- ▶ Railway technology and signalling
- ▶ Automation
- ▶ Medical devices
- ▶ Radio technology and telecontrol
- ▶ Firing technology
- ▶ Process technology
- ▶ Elevators and hoists

The right relay for each safety-related application. Safety relays by DOLD are available in a wide variety of contact versions and designs. Also in custom designs. What can we do for you?

Safety relays with high switching capacity



OA 5601



OA 5602



OA 5603



OA 5611



OA 5612

Safety relays in compact design



OA 5667



OA 5669



OA 5670



OA 5621



OA 5622

Further information

Start



Safety relays OA 5621/22/23

DOLD 

Up to 8 forcibly guided contacts -
monostable

In safety-critical applications in which relays with forcibly guided contacts (in accordance with DIN EN 61810-3) are used, a compact size and shape are especially important, as is a high level of switching reliability. In addition, this relay stands out for its good vibration and shock resistance.

The **safety relays OA 5621** and **OA 5622** have enjoyed great success on the market for many years. Now, our existing relay family with 4 and 6 poles is growing adding new designs. The **8-pole safety relay OA 5623** responds to the need for more contacts in an even more compact design. With a short overall height of just 15.8 mm and a small base area, it can be easily installed in safety switching devices with only 22.5 mm width.

Reducing the coil voltage makes it possible to lower the holding power to a quarter of rated power. The relays are wash proof (RT III), have a temperature range of up to 80° C, and are available with contact materials of silver tin oxide (AgSnO₂) and silver-nickel (AgNi), as well as hard gold plating.

Advantages and customer benefit

- ▶ Compact size, short overall height
- ▶ Optionally available with contact opening 1.0 mm in fault free condition
- ▶ Low rated and holding power
- ▶ Safe separation between all circuits;
for applications at contamination level: 2; with rated insulation voltage 250 V
- ▶ Optionally available with gold plated double contacts (OA 5621, OA 5622)
- ▶ Common pin arrangement of relays family
- ▶ Wide temperature range
- ▶ Optionally available with offset pins for optimized spacing and a simpler layout design
- ▶ Wash-proof design

Our experience. Your safety.

Safety relays OA 5621, OA 5622, OA 5623

Technical features	OA 5621	OA 5622	OA 5623
Overall height	▶ 15.5 mm	15.5 mm	15.8 mm
Base area	▶ 46.5 x 22 mm	55 x 22 mm	67 x 22 mm
Rated consumption	▶ 0.6 W	0.8 W	1.2 W
Switching current	▶ 10 mA to 8 A	10 mA to 8 A	10 mA to 8 A
Contacts	▶ 4 2NO/2NC; 3NO/1NC	6 3NO/3NC; 4NO/2NC; 5NO/1NC	8 7NO/1NC; 6NO/2NC; 5NO/3NC; 4NO/4NC;
Contact material	▶ AgSnO ₂ , AgNi, AgNi + hard gold plating		
Temperature range	▶ - 40 ... + 80° C		
Approvals	▶ cRUus, TÜV		



OA 5621



OA 5622



OA 5623

Order information

The contact materials AgSnO₂, AgNi and AgNi + hard gold plating are available. Double contacts are also available upon request. When used with our popular mini crown, currents from 10 mA to 8 A can be switched reliably. Since almost all coil voltages between 6 V and 110 V are available, you will receive a safety relay designed for your specific application.

Please feel free to ask any questions you may have.

Areas of application

- ▶ Railway and signaling technologies
- ▶ Automation
- ▶ Medical devices
- ▶ Radio and remote control technology
- ▶ Firing technology
- ▶ Process technology
- ▶ Elevator technology

The right relay for every safety-critical application. Safety relays from DOLD are available in a wide range of contact variations, shapes, and sizes. We also produce customer-specific designs.

And what can we do for you?

Safety relays with high switching capacity



OA 5601



OA 5602

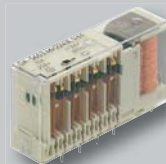

OA 5603



OA 5611

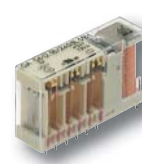

OA 5612

Safety relays in compact design



OA 5642



OA 5643



OA 5644



OA 5667



OA 5669



OA 5670

Further information

OA 5623

Start

www.dold.com



E. Dold & Söhne GmbH & Co. KG
 Bregstraße 18 • D-78120 Furtwangen
 T +49 7723 654-0 • F +49 7723 654-356
 dold-relays@dold.com • www.dold.com



Bistable relay OB 5623

With 8 forcibly guided contacts
for energy-efficient design

DOLD 

Specialized applications need relays that maintain their switching position if supply voltage fails, thereby preventing a loss of information on the current switched state. The **bistable relay OB 5623**, with its unique construction, was developed for these applications. In addition, this relay stands out for its good vibration and shock resistance.

Short switching pulses of just a few milliseconds bring the relay into a defined switched position. Only a low rated power of 1.2 W (lock) and 0.7 W (unlock) is required. The holding power is 0 Watt! This saves a large amount of energy and reduces self-heating. Designing today, for tomorrow. Let the energy revolution come.

The special feature of forcibly guided contacts (DIN EN 61810-3) enables reliable detection of the contact position. These features make the OB 5623 destined for use in challenging applications. If desired, you can purchase the relay as a manually-operated version (switch position indicator). Both designs of the OB 5623 offer a temperature range of up to 75° C. They are available with contact materials silver-nickel (AgNi) or silver-nickel + hard gold plating.

Advantages and customer benefit

- ▶ Energy efficient
Low rated power to change the switching position, no holding power
- ▶ Optionally available with contact opening 1.0 mm in fault free condition
- ▶ Forcibly guided contacts in accordance with DIN EN 61810-3
- ▶ Compact size, short overall height 15.8 mm
- ▶ Safe separation between all circuits;
For applications at contamination level: 2; with rated insulation voltage 250 V
- ▶ Wide temperature range
- ▶ Optionally available with manual activation (switched position display)

Our experience. Your safety.

Bistable relay OB 5623

Technical features

OB 5623

Overall height	▶ 15.8 mm
Base area	▶ 83 x 22 mm
Rated consumption	▶ 1.2 W / 0.7 W
Switching current	▶ 10 mA to 8 A
Contacts	▶ 8
	4NO/4NC, others upon request
Contact material	▶ AgNi, AgNi + hard gold plating
Temperature range	▶ - 40 ... + 75° C
Approvals	▶ TÜV

Order information

The contact materials AgNi and AgNi + hard gold plating are available. Double contacts are also available upon request. When used with our popular mini crown, currents from 10 mA to 8 A can be switched reliably. Since almost all coil voltages between 6 V and 110 V are available, you will receive a bistable relay designed for your specific application.
Please feel free to ask any questions you may have.

Areas of application

- ▶ Railway and signaling technologies
- ▶ Automation
- ▶ Medical devices
- ▶ Radio and remote control technology
- ▶ Firing technology
- ▶ Process technology

The right relay for your application. Bistable relays from DOLD are available in a wide range of contact variants and designs.
 And what can we do for you?

Bistable relays in compact design



OR 5691



OB 5693



OB 5694

Safety relays with forcibly guided contacts



OA 5601
OA 5602
OA 5603



OA 5611
OA 5612



OA 5621
OA 5622
OA 5623

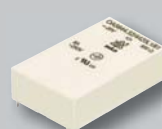

OA 5642
OA 5643
OA 5644



OA 5667



OA 5669
OA 5670

Further information

Start

www.dold.com



OB 5623
With manual activation



OB 5623
Without manual activation

DOLD

E. Dold & Söhne GmbH & Co. KG
 Bregstraße 18 • D-78120 Furtwangen
 T +49 7723 654-0 • F +49 7723 654-356
 dold-relays@dold.com • www.dold.com



From a regional Black Forest company to a specialist company with worldwide success – we are always available to assist you with sales partners on all continents.

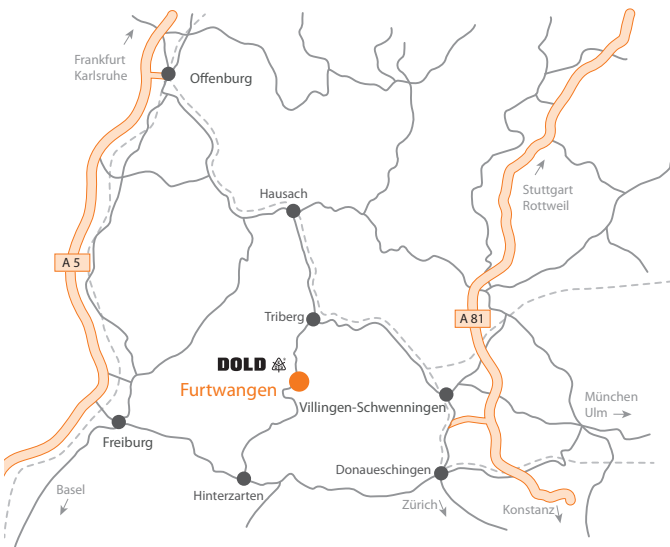

Right from the beginning, the aim of the company, founded in 1928 by Emil Dold, was to provide the highest safety and customer satisfaction through innovative products. Dold has successfully managed to undergo continuous development: from paving the way as a pioneer in relay technology to being the leading industry representative in Europe for safety and monitoring technology as well as power electronics with over 400 members of staff worldwide.

Our experience. Your safety.
Challenge us. We look forward to finding the solution!



E. Dold & Söhne GmbH & Co. KG
Bregstraße 18 • D-78120 Furtwangen
T +49 7723 654-0 • F +49 7723 654-356
dold-relays@dold.com • www.dold.com

